

AQUATICS/TRACK LED SCOREBOARDS

DISPLAY MANUAL

P1153

DD3043167
Rev 04
03 August 2021

Models		
SW-2101	SW-2216	SW-2008
SW-2106	SW-2118	SW-2009
SW-2108	SW-2220	SW-3104
SW-2110	SW-2001	SW-3108
SW-2116	SW-2002	SW-3118
SW-2118	SW-2003	
SW-2120	SW-2004	
SW-2206	SW-2005	
SW-2208	SW-2006	
SW-2210	SW-2007	

FCC Statement

Supplier Declaration of Conformity (SDoC)

This product complies with Part 15 of the FCC Rules. Operation is subject to the following two conditions: (1) This device may not cause harmful interference, and (2) this device must accept any interference received, including interference that may cause undesired operation.

Note: This equipment has been tested and found to comply with the limits for a Class A digital device, pursuant to part 15 of the FCC Rules. These limits are designed to provide reasonable protection against harmful interference when the equipment is operated in a commercial environment. This equipment generates, uses, and can radiate radio frequency energy and, if not installed and used in accordance with the instruction manual, may cause harmful interference to radio communications. Operation of this equipment in a residential area is likely to cause harmful interference in which case the user will be required to correct the interference at their own expense.

Warning: The user is cautioned that changes and modifications made to the equipment without the approval of manufacturer could void the user's authority to operate this equipment.

Industry Canada Regulatory Information

This Class A digital apparatus complies with Canadian ICES-003.

Cet appareil numérique de la classe A est conforme à la norme NMB-003 du Canada.

Inquiries

Contact Daktronics with any questions regarding our product compliance.

Mail:

Daktronics
201 Daktronics Dr.
Brookings, SD 57006 USA

Phone:

800-325-8766

Website:

www.daktronics.com



DAKTRONICS

Copyright © 2015-2021

All rights reserved. While every precaution has been taken in the preparation of this manual, the publisher assumes no responsibility for errors or omissions. No part of this book covered by the copyrights hereon may be reproduced or copied in any form or by any means—graphic, electronic, or mechanical, including photocopying, taping, or information storage and retrieval systems—without written permission of the publisher.

Daktronics trademarks are property of Daktronics, Inc. All other trademarks are property of their respective companies.

Table of Contents

1	Introduction	1
	Important Safeguards.....	1
	Specifications Label.....	1
	Model Descriptions.....	1
	Resources.....	2
	Daktronics Nomenclature.....	2
	Display Controllers.....	3
	Product Safety Approval.....	3
2	Mechanical Installation	4
	Installing Caption Modules.....	4
	Wall Mounting Digit Modules.....	5
	SW-3104	5
	Vertical Wall Mounting (Indoor or Outdoor)	5
	Horizontal Wall Mounting (Indoor Only)	6
	Corner-Mounting (Indoor Only)	6
	Beam Mounting (Outdoor).....	7
3	Electrical Installation	8
	Indoor Scoreboard Power.....	8
	Grounding	8
	Power Connection	8
	Outdoor Scoreboard Power.....	9
	Grounding	9
	Installation with Ground and Neutral Conductors Provided.....	9
	Installation with Only a Neutral Conductor Provided.....	10
	Lightning Protection	10
	Installing Load Centers	10
	Connection	10
	Power-On Self-Test (POST).....	11
	Indoor Signal Connection.....	12
	Outdoor Signal Connection.....	12
	Wireless Signal Connection.....	13
	Internal Cable Routing (Horizontal Models Only).....	13
	Setting the Driver Address.....	13
4	Troubleshooting	17
	Troubleshooting Table.....	17
	Component Locations and Access.....	19
	Replacing Digits.....	19
	Segmentation and Digit Designation.....	20
	LED Drivers.....	20
	Replacing a Driver	21
	Radio Connections.....	21
	Radio Interference	22

Table of Contents

Schematics.....	22
Replacement Parts.....	23
5 Daktronics Exchange and Repair & Return Programs	24
Exchange Program	24
Repair & Return Program.....	25
Daktronics Warranty & Limitation of Liability	25
A Mechanical Drawings	27
B Electrical Drawings	51
C Daktronics Warranty & Limitation of Liability	79

1 Introduction

This manual explains the installation of Daktronics Aquatics/Track LED Scoreboards. For additional information regarding the safety, installation, operation, or service of these displays, refer to the telephone numbers listed in **Section 5: Daktronics Exchange and Repair & Return Programs (p.24)**. This manual is not specific to a particular installation.

Important Safeguards

- **Read and understand all instructions before beginning the installation process.**
- **Properly ground the cabinet with a grounding electrode at the display location.**
- **Disconnect the display power when not in use or when servicing.**
- **Disconnect the display power before servicing power supplies to avoid electrical shock. Power supplies run on high voltage and may cause physical injury if touched while powered.**
- **Do not modify the structure or attach any panels or coverings to the display without the express written consent of Daktronics.**
- **Do not disassemble control equipment or electronic controls of the display; failure to follow this safeguard will make the warranty null and void.**
- **Do not drop the control equipment or allow it to get wet.**

Specifications Label

Power specifications as well as serial and model number information can be found on an ID label, similar to the one shown in **Figure 1**.

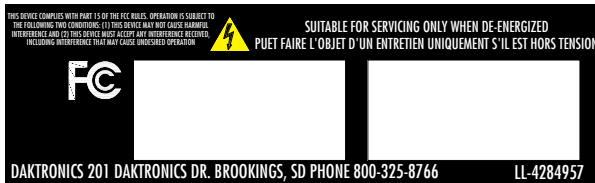

Figure 1: Specifications Label

Please have the assembly number, model number, and the date manufactured on hand when calling Daktronics customer service to ensure the request is serviced as quickly as possible. Knowing the facility name and/or job number will also be helpful.

Model Descriptions

Reference Drawings:

Module Model Descriptions	DWG-129639
Model Configurations, Swim / Track Timing.....	DWG-130101
Model Configurations, Aquatics Multisport	DWG-130102

To determine which pieces make up what model and how they are arranged, refer to **DWG-130101** and **DWG-130102** in **Appendix A**. Refer also to **DWG-129639** for detailed views of each display piece and add-on modules.

Resources

Figure 2 illustrates a Daktronics drawing label. This manual refers to drawings by listing the last set of digits. In the example, the drawing would be referred to as **DWG-1007804**. All references to drawing numbers, appendices, figures, or other manuals are presented in bold typeface. Any drawings referenced in a section are listed at the beginning of it as shown below:

 DAKTRONICS, INC. BROOKINGS, SD 57006 DO NOT SCALE DRAWING		THE CONCEPTS EXPRESSED AND DETAILS SHOWN ON THIS DRAWING ARE CONFIDENTIAL AND PROPRIETARY. DO NOT REPRODUCE BY ANY MEANS WITHOUT THE EXPRESSED WRITTEN CONSENT OF DAKTRONICS, INC. COPYRIGHT 2010 DAKTRONICS, INC.
PROJ: DAKTRONICS TITLE: SYSTEM RISER DIAGRAM		
DESIGN:	DRAWN: APAGE	DATE: 11 MAY 10
SCALE: NONE		
SHEET	REV	JOB NO.
200	02	C17581
FUNC-TYPE-SIZE		1007804
F-01-D		

Drawing Number

Figure 2: Drawing Label

Reference Drawings:

System Riser Diagram **DWG-1007804**

Daktronics identifies manuals by the DD or ED number located on the cover page.

Listed below are drawing types commonly used by Daktronics, along with the information typically provided. All drawings referenced in this manual are found in the appendices.

- **Schematic Drawings:** describe internal power and signal wiring as well as interconnections between display sections; they may also include digit designations and driver addressing information
- **Shop Drawings:** describe mounting methods to structural elements, access method (front or rear), and power and signal entrance points
- **System Riser Diagrams:** describe power/signal connections between components and the control location; they may also include control room layout and schematic
- **Final Assembly Drawings:** describe internal component locations and detailed product appearance with part numbers and quantities

Project-specific information takes precedence over any other general information found in this manual. Ensure all applicable material has been gathered before beginning the installation. Contact a Daktronics sales coordinator or project manager.

Daktronics Nomenclature

Most display components have a white label that lists the part number (**Figure 3**). Part numbers will also appear on certain drawings. If a component is not found in the **Replacement Parts (p.23)**, use the label to order a replacement. Refer to **Section 5: Daktronics Exchange and Repair & Return Programs (p.24)** if replacing or repairing any display component.

0P-1127-0024
SN: 2465
02/19/12 Rev. 1

Figure 3: Part Label

Main Component Labels	
Part Type	Part Number
Individual circuit board	0P-XXXX-XXXX
Assembly; a collection of circuit boards	0A-XXXX-XXXX
Wire or cable	W-XXXX
Fuse	F-XXXX
Transformer	T-XXXX
Metal part	0M-XXXXXXX
Fabricated metal assembly	0S-XXXXXX
Specially ordered part	PR-XXXXX-X

Accessory Labels	
Component	Label
Termination block for power or signal cable	TBXX
Grounding point	EXX
Power or signal jack	JXX
Power or signal plug for the opposite jack	PXX

Display Controllers

The OmniSport 2000 timing console uses keyboard overlays (sport inserts) to control numerous sports and display models. Refer to the manual below for operating instructions. The manual is provided on a CD with the control consoles, and also available online at www.daktronics.com/manuals.

- **OmniSport 2000 Timing Console Operation Manual (ED-13312)**

It is also possible for these displays to be controlled via third-party timing consoles, such as those produced by Omega and Colorado Timing Systems (CTS). In these cases, refer to the documentation provided by the manufacturer.

Product Safety Approval

Daktronics outdoor displays are ETL-listed and tested to CSA standards for outdoor use. Contact Daktronics with any questions regarding testing procedures.

2 Mechanical Installation

Refer to the electrical installation drawing before beginning the mechanical installation procedure. It is important to recognize where the electrical wires are located so knockouts can be removed respectively before the display has been mounted. It will be easier to install electrical hookup items, route conduits, and attach hookup boxes before mechanical installation.

- For indoor scoreboards, mechanical installation typically consists of lifting and permanently mounting the scoreboard to a wall. The mechanical specification drawings listed in **Appendix A** show the recommended number and spacing of wall anchors for indoor scoreboard models.
- For outdoor scoreboards, mechanical installation typically consists of installing concrete footing and steel beams and mounting the scoreboard to the beams. The columns, footings, and all connection details must be designed and certified by a professional engineer licensed to practice in the state of the scoreboard installation.

Be sure that the installation complies with local building codes.

Note: Daktronics assumes no liability for any installation derived from the information provided in this manual or installations designed and installed by others.

Installing Caption Modules

Reference Drawings:

Caption Layout- 6-Lane Multi-Sport Systems	DWG-130319
Caption Layout- 8-Lane Multi-Sport Systems	DWG-130321
Caption Layout- 10-Lane Multi-Sport Systems	DWG-130801
Caption Module Detail	DWG-130840

Note: Attach the caption module to the digit module *before* attaching the digit module to the wall.

The caption modules are attached to the top or bottom of a digit module with #10 machine screws (refer to **DWG-130840**). Before attaching the caption module, note its orientation. The top and bottom guides for holding the caption panel are different sizes. Be sure the module is oriented so that the deeper guide is toward the top.

To insert a caption panel, fit the top edge of the caption panel into the module's upper guide, and then slide the bottom edge under the lower guide (refer to **DWG-130840**). The construction of the guides allows the caption panels to be lifted out for changing, rather than having to slide them out one end.

The caption panels must be properly positioned in relation to the scoreboard digits for different activities. Refer to **DWG-130319**, **DWG-130321**, and **DWG-130801** for caption layouts. The drawings indicate the proper location of the digits and caption panels that will be used for the various events and sports.

Wall Mounting Digit Modules

Due to the variety of wall materials used in sports facilities, Daktronics cannot anticipate a user's individual installation needs or provide mounting hardware suitable for every installation. Choose a method of installation that will safely support the weight of the display.

Before installing any wall anchors or the mounting structure, determine where all of the mounting holes will be located on the display modules. Holes provided on the modules should be convenient for most installations.

For mounting locations, weights, and hardware suggestions, refer to the model-specific mechanical specification drawings listed in **Appendix A**.

SW-3104

Reference Drawings:

SW-3104 Floor Stand Assy..... **DWG-253540**

The SW-2104 features carrying handles and may not need to be wall mounted. However, it may be mounted to a floor stand for greater stability. Refer to **DWG-253540**.

Vertical Wall Mounting (Indoor or Outdoor)

Reference Drawings:

Vertical Wall Mount **DWG-130545**

Use this method when the overall display has modules mounted on top of one another.

1. Before attaching the digit module to the wall, attach the caption module to the digit module as described in **Installing Caption Modules (p.4)**.

Note: Extra strut length is not required when caption modules are mounted at either the top or bottom of the column.

2. Attach vertical mounting struts to the wall. Strut length will vary depending on the total number of display modules. Center-to-center distance between vertical struts is 8'-10.5" (2705 mm) for 9' (2743 mm) wide modules.
3. Use 3/8" bolts to attach the modules to spring nuts in the struts (**Figure 4**). Mount the lowest module first, and then add modules working upward.

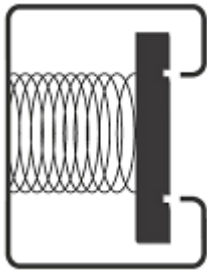

Figure 4: Spring Nut in Strut

Horizontal Wall Mounting (Indoor Only)

Reference Drawings:

Strut Spacing, Horizontal Wall Mounting.....	DWG-129905
End Bracket Attachment, Horizontal Wall Mounting.....	DWG-129906
Horizontal Wall Mounting, Final Steps.....	DWG-129907

Use this method when the overall display has modules mounted side by side.

1. Before attaching the digit module to the wall, attach the caption module to the digit module as described in **Installing Caption Modules (p.4)**.

<p>Note: Extra strut length is not required when caption modules are mounted at either the top or bottom of the column.</p>
--

2. Attach mounting struts to the wall. Strut length will vary depending on the total number of display modules. Refer to **DWG-129905** to determine strut length and the center-to-center distance between the struts.
3. Attach the end brackets to the right end of all the modules in the left column. Next, attach brackets to the left end of all the modules in the right column. Refer to **DWG-129906**.
4. Use 3/8" bolts to attach the modules in the left column to spring nuts in the struts (**Figure 4**). Mount the lowest module first, and then add modules working upward.
5. Starting with the bottom-right module, insert the screw heads on the end brackets of the left side of the cabinet into the keyholes on the mating bracket of the right side of the left column cabinet, and press down on the right side until both cabinets are flush and level horizontally. Refer to **DWG-129907**.
6. Once the right column cabinet is joined to the left column cabinet, use 3/8" bolts to attach the right end of the right column module to spring nuts in the struts (**Figure 4**).
7. Repeat **Steps 5–6** for all remaining right column modules, working upward.

Corner-Mounting (Indoor Only)

Reference Drawings:

Corner Mount.....	DWG-130508
-------------------	-------------------

If the display is to be mounted across the corner of adjoining walls, corner-mounting brackets may be ordered as an option. **DWG-130508** details this type of mounting.

Multi-line display models that use a single vertical arrangement of modules may be mounted with corner brackets. However, horizontal display configurations cannot be mounted across a corner using the simple brackets. Such displays must be attached to a structure or framework that spans across the corner and safely supports the entire display. This type of mounting must be designed by a qualified engineer.

Beam Mounting (Outdoor)

Reference Drawings:

Beam Mounting Procedure.....	DWG-194664
Beam Mounting, Side View	DWG-194671
Beam Mounting, Top View	DWG-194674
Beam Mounting, Rear View, Vertical Display.....	DWG-194677
Beam Mounting, Rear View, Horizontal Display.....	DWG-194678

Daktronics outdoor scoreboards are typically mounted on steel beams. Such beam-mounted installations require that a qualified engineer provide specifications for both the reinforced concrete footings and the steel support beams.

Two beams are required for each column of display modules. Beams must be set 4'-6" (1372 mm) apart, center-to-center. Installations of vertical and horizontal displays are shown in **DWG-194677** and **DWG-194678**.

Note: Because every display is different in terms of module configuration, scoreboard options, and environments, every installation will be unique.

Once the support beams are installed, refer to **DWG-194664**, **DWG-194671**, and **DWG-194674** along with the instructions below to mount the display modules to the beams.

1. Begin by attaching mounting brackets to the top and bottom of the lowest digit module in the display. The brackets are fastened to the modules by inserting 10-24 x 5/8" screws through the holes in each bracket and threading them into the captivated nuts on the back of the module.
2. With the brackets attached, position the module against the beam and secure it with the 1/2-13 x 15" threaded rods, lock washers, and nuts provided. The rods do not go through the beam but pass along either side; no drilling is required. The square nuts go inside the bracket, while the lock washers and hex nuts are used outside the rear mounting angles that straddle the back of each beam. Tighten the assembly with a 3/4" socket.

Note: Do not over tighten the assembly as it may deform the brackets and angles.

3. Attach the upper mounting brackets to the next module and position it against the beams, on top of the first module.
4. Insert screws through the upper brackets of the lower module to secure the bottom of the upper module. This secures the brackets to the back of both modules.
5. Secure the upper brackets of the upper module to the beams with bolts, washers, and nuts as described in **Step 2**.
6. Join the modules together at both ends by inserting screws up through the holes in the top of the lower module into the captivated nuts in the bottom of the upper module.
7. The building process continues in the same manner for all remaining modules. Caption modules are attached directly to their adjoining digit modules, similar to the process outlined in **Step 6**; they do not accept beam mounting brackets.

3 Electrical Installation

CAUTION: Only qualified individuals should perform routing and termination to the display. Electrical contractors are responsible for ensuring that all electrical work meets or exceeds local and national codes. Daktronics engineering staff must approve all changes or the warranty will be void.

Refer to the specification label (**Figure 1**) on the display to determine maximum power requirements. Ensure all external overcurrent protection meets all local and national electrical codes and is appropriately sized to the load it is terminating. Failure to meet wiring and overcurrent protection device requirements will void the warranty.

Note: Ensure the display is on a dedicated circuit. This will prevent loss of critical game/event information that may otherwise occur if another component on the same circuit should fail.

Indoor Scoreboard Power

Grounding

All components of a display system – including but not limited to displays, control equipment, and connected peripheral equipment – must be electrically grounded. Only qualified individuals may perform electrical work, including verification of ground resistance. Daktronics is not responsible for improper grounding or damage incurred as a result of improper grounding.

Grounding methods must meet the provisions of all applicable local and national codes. Inspect and verify all grounding methods meet the provisions of all applicable local and national codes.

Proper grounding is necessary for reliable equipment operation and general electrical safety. Failure to properly ground the display system may void the warranty, disrupt operation, damage equipment, and cause bodily harm or death.

Power Connection

Reference Drawings:

Electrical Hookup- Indoor Display- 120 V	DWG-130661
Electrical Hookup- Indoor Display- 230 V	DWG-130676

Indoor scoreboards feature a 120 VAC power cord with a three-prong plug. Install a grounded receptacle near the equipment so that the power cord can easily reach it. Displays operating on 230 VAC are also available, and they ship equipped with a universal power plug. The control console requires a 120 VAC receptacle and uses less than 1 A of power.

Note: If the power cord is not already installed, refer to **DWG-130661** for 120 VAC displays or **DWG-130676** for 230 VAC displays.

1. Open the bottom-left panel of the lowest digit module of the display.
2. Mount the power/signal plate in the left side of the lowest digit module of the display. Remove both the 2" knockout and the upper 7/8" knockout from the left end of the module. Route the power cord out of the module through the knockout and position the plate inside, on the end. Secure the plate with two screws, inserting them externally through the pre-drilled holes.
3. Route the cable from the power/signal plate into the driver enclosure and connect the 5-pin **J51** jack to the mating **P51** plug.
4. Insert 2" bushings into the holes between modules.
5. Pull the power/signal cable from the lower module through the 2" hole in the top of the cabinet up into the next module and connect the 5-pin **J51** jack to the mating **P51** plug in the driver enclosure.
6. Repeat the connection process in **Step 5** with any other modules in the system.
7. Connect the power cord to a 120 VAC power outlet.
8. Replace the front panel. Insert a 2" plug in the bottom hole of the lowest module.

The hookup procedure for a 230 V display is identical; the only difference between the two electrical systems is the power cord. Refer to **DWG-130676**.

Outdoor Scoreboard Power

Grounding

All components of a display system – including but not limited to displays, control equipment, and connected peripheral equipment – must be electrically grounded. Only qualified individuals may perform electrical work, including verification of ground resistance. Daktronics is not responsible for improper grounding or damage incurred as a result of improper grounding.

Grounding methods must meet the provisions of all applicable local and national codes. Inspect and verify all grounding methods meet the provisions of all applicable local and national codes.

Proper grounding is necessary for reliable equipment operation and general electrical safety. Failure to properly ground the display system may void the warranty, disrupt operation, damage equipment, and cause bodily harm or death.

There are two types of power installation: installation with ground and neutral conductors provided, and installation with only a neutral conductor provided. These two power installations differ slightly, as described in the following subsections:

Installation with Ground and Neutral Conductors Provided

For this type of installation, the power circuit must contain an isolated earth-ground conductor. In this circumstance, do not connect neutral to ground at the disconnect or at the display as this would violate electrical codes and void the warranty.

Use a disconnect so that all ungrounded lines can be disconnected. The local and national electrical codes may require using a lockable power disconnect at or within sight of the display.

Installation with Only a Neutral Conductor Provided

Installations where no grounding conductor is provided must comply with local and national electrical codes. If the installation meets all requirements, observe the following guidelines:

- Connect the grounding electrode cable at the local disconnect, never at the display driver/power enclosure.
- Use a disconnect that opens all of the ungrounded phase conductors.

Lightning Protection

The use of a disconnect near the display location to completely cut all current-carrying lines significantly protects the circuits against lightning damage. Local and national electrical codes may also require it. In order for this system to provide protection, the power must be disconnected when the display is not in use.

The control console also should be disconnected from power and from the signal junction box when the system is not in use. The same surges that may damage the display components can also damage the console's circuitry.

Installing Load Centers

Reference Drawings:

Electrical Hookup- Outdoor Display **DWG-129998**

Outdoor displays have a fully-enclosed load center that brings power and signal to the scoreboard. The harsher environment and outdoor electrical hookup requirements mandate the use of this component. Refer to **DWG-129998** along with the instructions below to mount the load center in the display during installation.

1. Remove the lower left panels from the lowest digit module in the display, and remove the nuts from the three screws already installed in the cabinet.
2. If the load center cover is on, remove it. Position the load center on the back panel screws, and complete the mounting by tightening the nuts.
3. Route the cable from the load center into the driver enclosure and connect the 5-pin **J51** jack to the mating **P51** plug.

Connection

Power and signal cables are routed into the display from the rear via separate conduits. All power and signal wiring terminates at the load center. Note that systems with radio control typically only require signal wiring for backup purposes.

Refer to the electrical specification drawings listed in **Appendix B** to locate the front access panel to the load center enclosure. Remove the screws to open the access panel. Remove the metal cover of the load center to expose the components.

Connect the appropriate wires coming through the rear of the scoreboard to the load center terminals, as described below and shown in **Figure 5**.

- live wire (black) to **LINE 1**
- neutral (white) wire to **NEUT**.
- ground wire (green/yellow) to the grounding buss bar

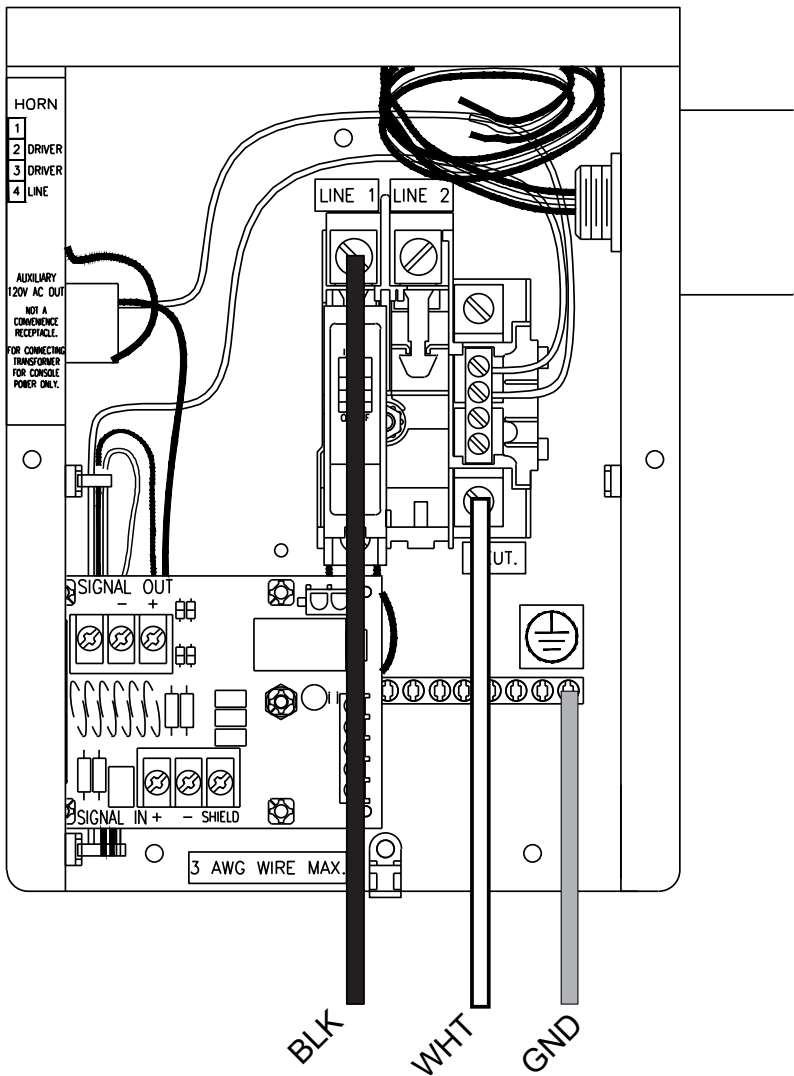

Figure 5: Load Center Power Connections (Cover Removed)

Power-On Self-Test (POST)

The display performs a self-test each time that power is turned on and the control console is powered off or not connected. If the control console is connected and powered on, the self-test does not run, and data from the control console appears on the display after a few seconds. Each self-test pattern will vary depending on the model, the number of drivers, and types of digits. **Figure 6** shows an example of the LED bar test pattern that each digit performs.

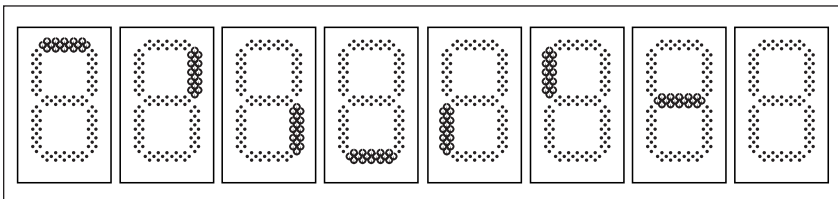

Figure 6: Digit Segment POST

Indoor Signal Connection

Wired signal installation requires routing control cable from the control console to a signal junction box (J-box) near the display. At a minimum, use a paired, 22 AWG shielded cable (Daktronics part # W-1077).

1. Route signal cable in conduit from the display location to a signal junction box (J-box) or wall plate near the control location.
2. Install the 1/4" phone plug (part # 0L-40683) to the display end of the cable.
3. Insert the plug into the **SIGNAL IN** jack located on the left side of the display.

Note: If the signal jack is not already installed, refer to **Power Connection (p.8)**.

4. Connect a signal cable from the J-box or wall plate on the control console end to the **J1**, **J2**, or **J3** jack on the back of the OmniSport 2000 console.
 - If using a Main Clock Start/Stop Switch (part # 0A-1166-0003), connect it to the **J8** jack on the OmniSport 2000 console.
 - If using a Shot Clock Start/Stop Switch (part # 0A-1196-0031), connect it to the **J9** jack on the OmniSport 2000 console.

Outdoor Signal Connection

Route copper signal cable through the conduit knockout on the rear of the display to the signal surge arrestor card (**Figure 7**), located in the load center.

At the **SIGNAL IN** terminal block, connect red signal wire to positive (+) and black signal wire to negative (-).

Note: Ensure shield (silver) wire is properly connected to the **SHIELD** terminal.

At a minimum, single-pair, shielded cable, 22 AWG (part # W-1077) is recommended.

Install an indoor or outdoor 1/4" J-box as needed at the control location, and connect a signal cable from the J-box on the control console end to the **J1**, **J2**, or **J3** jack on the back of the OmniSport 2000 console.

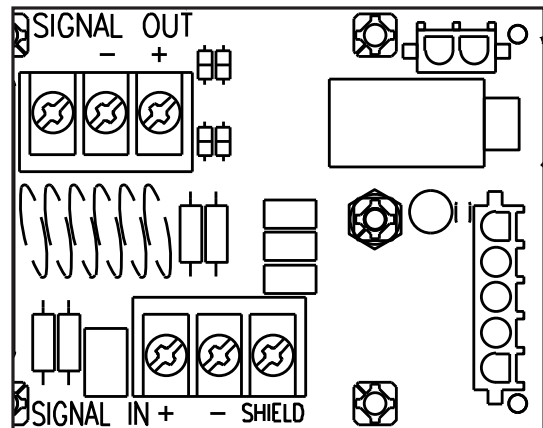

Figure 7: Signal Surge Arrestor Card

- If using a Main Clock Start/Stop Switch (part # 0A-1166-0003), connect it to the **J8** jack on the OmniSport 2000 console.
- If using a Shot Clock Start/Stop Switch (part # 0A-1196-0031), connect it to the **J9** jack on the OmniSport 2000 console.

Wireless Signal Connection

Reference Drawings:

Aquatics- Radio Hookup **DWG-305509**

A wireless radio system requires an OmniSport 2000 control console equipped with a radio transmitter as well as a radio receiver plugged into the 6-pin **J21** jack on the primary driver and mounted internally to the front panel of the display. Refer to **DWG-305509** in **Appendix B** for radio receiver installation instructions for both indoor and outdoor scoreboard models. For more information, refer to the **Gen VI Radio Installation Manual (DD2362277)**, provided with the receiver unit and available online at www.daktronics.com/manuals.

Internal Cable Routing (Horizontal Models Only)

Reference Drawings:

Internal Cable Routing..... **DWG-130679**

Horizontal, or side-by-side, modules require installation of a power/signal interconnect cable. Only one interconnect cable is needed for each installation. Refer to **DWG-130679**.

Connect the modules by running the interconnect cable from the driver of the bottom left module to the driver of the bottom right module. There are knockouts in the ends of the modules through which the cable may be run. The cable is connected with mating 5-pin plugs in each module.

Setting the Driver Address

Each driver in a scoreboard module must be set to receive the correct signal input, or address, for the control system being used.

Addresses are set through the S2 (L) and S3 (H) rotary switches on the driver (**Figure 8**) using a small flathead screwdriver.

Refer to the tables on the following pages to determine the correct driver address settings based on the control system in use.

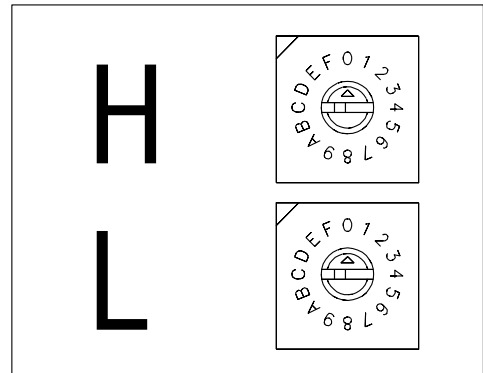

Figure 8: Driver Address Dials

Daktronics OmniSport 2000	
Function	Address
1-Line Timing Display	40 (H = 2, L = 8)
Line 1 (or 1 and 2)	41 (H = 2, L = 9)
Line 2 (or 2 and 3)	42 (H = 2, L = A)
Line 3 (or 3 and 4)	43 (H = 2, L = B)
Line 4 (or 4 and 5)	44 (H = 2, L = C)
Line 5 (or 5 and 6)	45 (H = 2, L = D)
Line 6 (or 6 and 7)	46 (H = 2, L = E)
Line 7 (or 7 and 8)	47 (H = 2, L = F)
Line 8 (or 8 and 9)	48 (H = 3, L = 0)
Line 9 (or 9 and 10)	49 (H = 3, L = 1)
Line 10	50 (H = 3, L = 2)
Home, Guest 1, Guest 2, Guest 3	31 (H = 1, L = F)
Event/Heat, Lengths, Record Time	32 (H = 2, L = 0)

Omega OSM6 or Scan'O'Vision	
Function	Address
Line 1 (or 1 and 2)	1 (H = 0, L = 1)
Line 2 (or 2 and 3)	2 (H = 0, L = 2)
Line 3 (or 3 and 4)	3 (H = 0, L = 3)
Line 4 (or 4 and 5)	4 (H = 0, L = 4)
Line 5 (or 5 and 6)	5 (H = 0, L = 5)
Line 6 (or 6 and 7)	6 (H = 0, L = 6)
Line 7 (or 7 and 8)	7 (H = 0, L = 7)
Line 8 (or 8 and 9)	8 (H = 0, L = 8)
Line 9 (or 9 and 10)	9 (H = 0, L = 9)
Line 10	10 (H = 0, L = A)
Line 4, MS w/ Horn	15 (H = 0, L = F)
Line 6, MS w/ Horn	16 (H = 1, L = 0)
Line 8, MS w/ Horn	17 (H = 1, L = 1)

Colorado Timing Systems (CTS)		
Function	Address	Define Module*
Line 1 (and 2)	1 (H = 0, L = 1)	01 (02)
Line 2 (and 3)	2 (H = 0, L = 2)	02 (03)
Line 3 (and 4)	3 (H = 0, L = 3)	03 (04)
Line 4 (and 5)	4 (H = 0, L = 4)	04 (05)
Line 5 (and 6)	5 (H = 0, L = 5)	05 (06)
Line 6 (and 7)	6 (H = 0, L = 6)	06 (07)
Line 7 (and 8)	7 (H = 0, L = 7)	07 (08)
Line 8 (and 9)	8 (H = 0, L = 8)	08 (09)
Line 9 (and 10)	9 (H = 0, L = 9)	09 (0A)
Line 10	10 (H = 0, L = A)	0A
Lengths, Record Time	11 (H = 0, L = B)	0B
Event/Heat		0C
Home, Guest	13 (H = 0, L = D)	0D
1-Line Timing Display	15 (H = 0, L = F)	0F
Home, Guest 1	20 (H = 1, L = 4)	14
Guest 2, Guest 3		15
Time of Day	22 (H = 1, L = 6)	16
Line 1, MS w/ Horn	41 (H = 2, L = 9)	01
Line 2, MS w/ Horn	42 (H = 2, L = A)	02
Line 3, MS w/ Horn	43 (H = 2, L = B)	03
Line 4, MS w/ Horn	44 (H = 2, L = C)	04
Line 5, MS w/ Horn	45 (H = 2, L = D)	05
Line 6, MS w/ Horn	46 (H = 2, L = E)	06
Line 7, MS w/ Horn	47 (H = 2, L = F)	07
Line 8, MS w/ Horn	48 (H = 3, L = 0)	08
Line 9, MS w/ Horn	49 (H = 3, L = 1)	09
Line 10, MS w/ Horn	50 (H = 3, L = 2)	0A

* Swim Mode Scoreboard Settings in Colorado Timers

Omega Ares 21	
Function	Address
Line 1 (or 1 and 2)	1 (H = 0, L = 1)
Line 2 (or 2 and 3)	2 (H = 0, L = 2)
Line 3 (or 3 and 4)	3 (H = 0, L = 3)
Line 4 (or 4 and 5)	4 (H = 0, L = 4)
Line 5 (or 5 and 6)	5 (H = 0, L = 5)
Line 6 (or 6 and 7)	6 (H = 0, L = 6)
Line 7 (or 7 and 8)	7 (H = 0, L = 7)
Line 8 (or 8 and 9)	8 (H = 0, L = 8)
Line 9 (or 9 and 10)	9 (H = 0, L = 9)
Line 10	10 (H = 0, L = A)
Event/Heat, Record Time	11 (H = 0, L = B)
Home, Guest 1, Guest 2, Guest 3	12 (H = 0, L = C)
Line 4, MS w/ Horn*	15 (H = 0, L = F)
Line 6, MS w/ Horn*	16 (H = 1, L = 0)
Line 8, MS w/ Horn*	17 (H = 1, L = 1)

* Operate in Swim Mode Only

Omega Quantum	
Function	Address
Line 1 (or 1 and 2)	1 (H = 0, L = 1)
Line 2 (or 2 and 3)	2 (H = 0, L = 2)
Line 3 (or 3 and 4)	3 (H = 0, L = 3)
Line 4 (or 4 and 5)	4 (H = 0, L = 4)
Line 5 (or 5 and 6)	5 (H = 0, L = 5)
Line 6 (or 6 and 7)	6 (H = 0, L = 6)
Line 7 (or 7 and 8)	7 (H = 0, L = 7)
Line 8 (or 8 and 9)	8 (H = 0, L = 8)
Line 9 (or 9 and 10)	9 (H = 0, L = 9)
Line 10	10 (H = 0, L = A)
Event/Heat, Record Time	18 (H = 1, L = 2)
Line 4, MS w/ Horn*	15 (H = 0, L = F)
Line 6, MS w/ Horn*	16 (H = 1, L = 0)
Line 8, MS w/ Horn*	17 (H = 1, L = 1)

* Operate in Swim Mode Only

FinishLynx	
Function	Address
Line 1 (or 1 and 2)	1 (H = 0, L = 1)
Line 2 (or 2 and 3)	2 (H = 0, L = 2)
Line 3 (or 3 and 4)	3 (H = 0, L = 3)
Line 4 (or 4 and 5)	4 (H = 0, L = 4)
Line 5 (or 5 and 6)	5 (H = 0, L = 5)
Line 6 (or 6 and 7)	6 (H = 0, L = 6)
Line 7 (or 7 and 8)	7 (H = 0, L = 7)
Line 8 (or 8 and 9)	8 (H = 0, L = 8)
Line 9 (or 9 and 10)	9 (H = 0, L = 9)
Line 10	10 (H = 0, L = A)
Event/Heat	11 (H = 0, L = B)

4 Troubleshooting

Disconnect power before doing any repair or maintenance work on the display.
Permit only qualified service personnel to access internal display electronics.
Disconnect power when not using the display.

Troubleshooting Table

This section lists potential problems with the system, indicates possible causes, and suggests corrective action. This list does not include every possible problem, but it does represent some of the more common situations that may occur.

Problem	Possible Cause	Solution/Items to Check
Display does not light, and console does not work	No power to the display	Check that the main circuit breaker for the display is on.
		Check that the display is receiving 120 or 240 VAC power.
	No power to the control console	Ensure the console is plugged into a 120 or 240 VAC power supply.
		Exchange the console with a working one, and enter the correct sport code and/or radio settings to test. Replace console if necessary.
Display digits do not light, but console works	No wired signal from control console	Check that the display is receiving 120 or 240 VAC power.
		Check that the red DS5 LED on the driver lights up when sending commands from the console. See LED Drivers (p.20) .
	No radio signal from control console	Verify that both the console and display antennas are securely tightened and in a vertical position.
		Keep the console 20–500' (6–152 m) away indoors or 20–1500' (6–457 m) outdoors. Check that the green POWER and amber RADIO IN RANGE indicators on the radio receiver in the display light up when the control console is powered on. Refer to Radio Connections (p.21) . Move the console 20–30' (6–9 m) from the display and test again.
		Replace the radio receiver.
	No signal to driver	Check that the display is receiving 120 or 240 VAC power.
		Check that the red DS5 LED on the driver lights up when sending commands from the console. See LED Drivers (p.20) .
		Exchange the driver with a working one of the same part #. Replace if necessary. See LED Drivers (p.20) .
	No power to driver	Check that the red DS8 LED on the driver remains lit up when the display is powered on. See LED Drivers (p.20) .

Problem	Possible Cause	Solution/Items to Check
Display digits light, but not in the correct order	Incorrect sport code	Ensure the correct sport code is being used for the display model. Refer to the appropriate console operation manual. See Display Controllers (p.3) .
	Incorrect driver address	Ensure all drivers are set to the correct address. See Setting the Driver Address (p.13) .
Digits light, console works, but nothing displays	No wired signal from control console	(see solution on previous page)
	No radio signal from control console	(see solution on previous page)
	Bad/damaged field wiring	Check that the red DS5 LED on the driver lights up when sending commands from the console. See LED Drivers (p.20) .
Display works, but some LEDs always stay on	Short in digit circuit	Exchange the digit with a working one of the same part # to verify the problem. Replace if necessary. See Replacing Digits (p.19) .
Display works, but some LEDs do not light or they blink	Bad connection	Verify the connector on the back of the digit circuit board is secure.
	Bad digit or driver	Exchange the digit or driver with a working one of the same part # to verify the problem. Replace if necessary. See Replacing Digits (p.19) or LED Drivers (p.20) .
Display works, but some digits do not light	Bad digit or driver	(see solution above)
	Incorrect sport code	(see solution above)
	Incorrect driver address	(see solution above)
	Wrong console controlling the display	Another console's radio signal may be transmitting to the display. Change the radio settings as described in Radio Connections (p.21) .
	Radio Interference	There may be other radio transmissions in the area that overpower the console. If it is not possible to disable the interfering device, it may be necessary to run a wired signal connection instead.
Display works, but one section of digits does not light	Bad multi-section connection	Verify power/signal interconnects between display sections are properly connected.
	Bad transformer	Exchange the transformer with a working one of the same part # to verify the problem. Replace if necessary.

Component Locations and Access

All internal electronic components and digits are reached by opening a digit/access panel on the front of the display. Component location varies with each model, but drivers and power and signal components are typically mounted behind the second panel from the left in the module. Refer to the electrical specification drawings listed in **Appendix B** for precise component locations.

Digit/access panels are held in place on the display face by screws. To remove a panel, simply unfasten the screws and carefully lift it from the cabinet.

Note: If the panel is not held in place when the screws are removed, it could drop and possibly damage LEDs or the digit harness.

When closing a digit/access panel, make sure all screws are holding it firmly in place to prevent excessive moisture and debris from entering the display.

Replacing Digits

Digits consist of a circuit board with embedded LEDs mounted to a black polycarbonate tray and encased in protective gel as shown in **Figure 9**. One or more digits may be secured to a single face panel. Do not attempt to remove individual LEDs; in the case of a malfunctioning LED or digit segment, replace the entire digit.

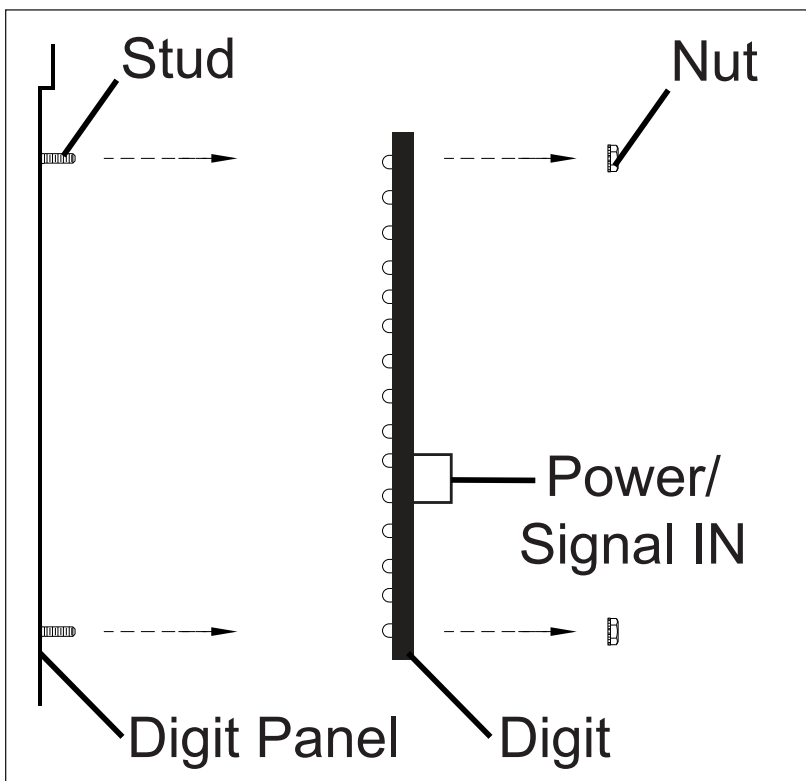

Figure 9: Weather-Sealed Digit Panel Assembly

To replace a digit:

1. Open the digit panel as described in **Component Locations and Access (p.19)**.
2. Disconnect the 9-pin plug from the back of the digit by squeezing the locking tabs together and pulling the connector free.
3. Use a 9/32" nut driver to remove the nuts securing the digits to the inside of the panel, and then lift the digit off the stud inserts.
4. Position a new digit over the studs, and then tighten the nuts.
5. Reconnect the 9-pin plug. This is a keyed connector and it will attach in one way only. Do not force the connection.
6. Secure the digit panel to the display face with the screws, and then power up and test the display to verify the issue has been resolved.

Segmentation and Digit Designation

Reference Drawings:

Segmentation, 7 Segment Bar Digit **DWG-38532**

In each digit, certain LEDs always go on and off together. These groupings of LEDs are referred to as segments. **DWG-38532** in **Appendix B** details which connector pin is wired to each digit segment and the wiring color code used throughout the display.

The Electrical Specification drawings in **Appendix B** also specify the driver connectors controlling the digits. Numbers shown in the upper half of each digit indicate which connector is wired to that digit.

LED Drivers

LED drivers perform the task of switching digits on and off within the display. LED drivers are mounted to a driver tray inside a protective enclosure. Refer to **Figure 10** to view the location and components of a driver tray.

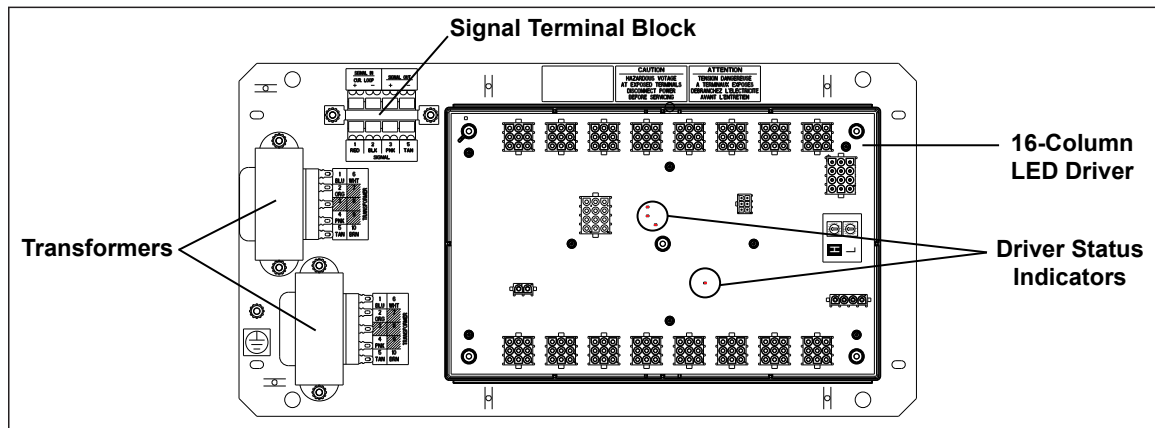

Figure 10: Driver Tray Components (Enclosure Cover Removed)

When troubleshooting driver problems, several LEDs provide diagnostic information.

Note: While it is necessary to have the display powered on to check the LED status indicators, always disconnect power before servicing.

LED	Function	Operation	Summary
DS1	Radio/ RS-232 RX	Blinking or off	DS1 will be blinking when the driver is receiving radio signal and off when there is no signal.
DS2	Status	Blinking	DS2 will be blinking at one second intervals to indicate the driver is running.
DS5	Signal RX	Blinking or off	DS5 will be blinking when the driver is receiving current loop signal and off when there is no signal.
DS8	Power	Steady on	DS8 will be on and steady to indicate driver has power.

Replacing a Driver

1. Open the access panel nearest the driver as described in **Component Locations and Access (p.19)**.
2. Remove the metal cover of the driver enclosure by lifting it up, then back and down to expose the driver components.
3. Disconnect all plugs from the driver by squeezing the locking tabs together and pulling the connectors free. It may be helpful to label the cables or take a picture to know which plug goes to which jack when connecting the replacement driver.
4. Remove the nuts securing the driver to the driver tray.
5. Carefully lift the driver from the display and place it on a clean, flat surface.
6. Position a new driver over the screws and tighten the nuts.
7. Reconnect all plugs to their mating jacks on the driver. The connectors are keyed and will attach in one way only. Do not force the connections.
8. Ensure the new driver is set to the correct address. This will be the same address of the old driver being replaced. Refer to **Setting the Driver Address (p.13)**.
9. Put the metal cover back on the enclosure, securely close the access panel, and then power up and test the display to verify the issue has been resolved.

Radio Connections

Reference Drawings:

Aquatics- Radio Hookup **DWG-305509**

If a radio receiver needs to be installed, refer to **DWG-305509** in **Appendix B**.

To determine the radio connection settings between the display and control console, first power off any radio-equipped consoles in the area, then cycle power to the display, and watch for the radio settings.

These settings appear in different locations based on the scoreboard layout, but typically in the first four digits of a standard lane module.

The scoreboard will display "bX CY" where X is the Broadcast group number and Y is the Channel number. The default is b1C1.

If these settings do not appear, the radio receiver may need to be repaired/replaced.

To make sure the console radio settings match the receiver in the display, refer to the appropriate control console manual listed in **Display Controllers (p.3)**.



Radio Interference

If it has been determined that a nearby display's radio signal is interfering, the settings of the radio receiver or wireless base station inside the display(s) must be changed.

1. To locate the radio receiver or base station, simply look for the black antenna sticking out the front of the display.
2. Open the access panel to which the receiver is attached as described in **Component Locations and Access (p.19)**.
3. The radio receiver has a plastic cover with a window to view status indicators (**Figure 11**).

Note: While it is necessary for the display to be powered on to check the indicators, always disconnect power before servicing.

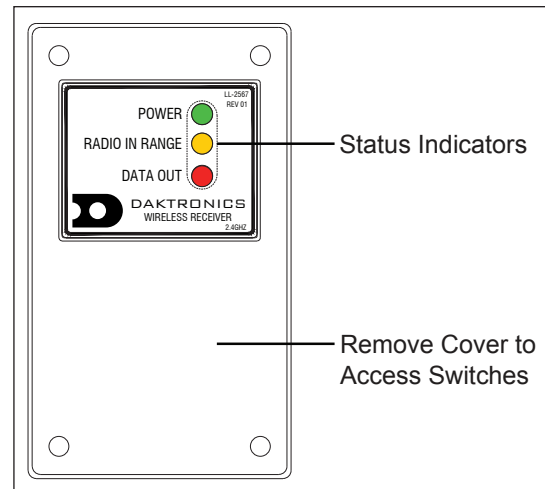

Figure 11: Radio Receiver w/ Cover

4. Remove the four screws in each corner using a #2 Philips screwdriver and lift off the cover.
5. Use a small flathead screwdriver to set the CHAN and BCAST switches to a new channel and broadcast group (1-8) as needed. Be sure to always leave FUNC set to "1". Refer to **Figure 12**.
6. Screw the cover back on and securely close the access panel.
7. Enter the correct sport code and new radio settings into the console to test the radio control. Refer to the appropriate control console manual listed in **Display Controllers (p.3)**.

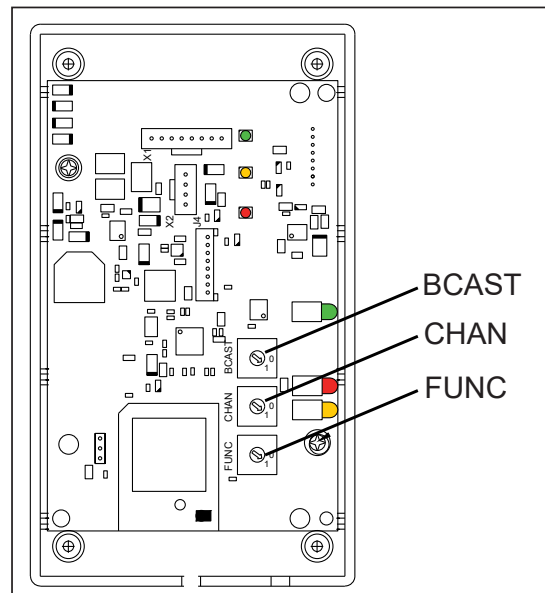

Figure 12: Radio Receiver Switches

For more information, refer to the **Gen VI Radio Installation Manual (DD2362277)**, available online at www.daktronics.com/manuals.

Schematics

For advanced troubleshooting and repair, it may be necessary to consult the schematic drawings. Listed in **Appendix B**, schematic drawings show detailed power and signal wiring diagrams of internal display components such as drivers, horn interface cards, and transformers as well as optional components like radio receivers.

Replacement Parts

The following table contains display components that may require replacement. Many of the other components will have attached part number labels.

Description	Part Number
Digit, 10" red LED, Outdoor	0A-1192-6121
Digit, 10" red LED, Indoor	0A-1192-5122
Digit, 10" amber LED, Outdoor	0A-1192-6221
Digit, 10" amber LED, Indoor	0A-1192-5222
16-Column LED Driver	0A-1782-0100
Signal Surge Card	0P-1110-0011
Digit, 5" red LED, 7-segment	0P-1192-1259
Digit, 5" amber LED, 7-segment	0P-1192-6260
Surge protector, 3 pole, 650 V	A-1489
Circuit Breaker, 15A, 120/240 VAC	S-1035
Transformer, 115/230 V @ 6.25 A	T-1066

5 Daktronics Exchange and Repair & Return Programs

Exchange Program

The Daktronics Exchange Program is a service for quickly replacing key components in need of repair. If a component fails, Daktronics sends a replacement part to the customer who, in turn, returns the failed component to Daktronics. This decreases equipment downtime. Customers who follow the program guidelines explained below will receive this service.

Before contacting Daktronics, identify these important numbers:

Model Number: _____

Assembly Number: _____

Job/Contract Number: _____

Date Manufactured/Installed: _____

Daktronics Customer ID Number: _____

To participate in the Exchange Program, follow these steps:

1. Call Daktronics Customer Service.

United States & Canada: 1-800-DAK-TRON (325-8766)

Outside the U.S. & Canada: +1-605-275-1040

2. When the new exchange part is received, mail the old part to Daktronics.

If the replacement part fixes the problem, send in the problem part being replaced.

- a. Package the old part in the same shipping materials in which the replacement part arrived.
- b. Fill out and attach the enclosed UPS shipping document.
- c. Ship the part to Daktronics.

3. The defective or unused parts must be returned to Daktronics within 5 weeks of initial order shipment.

If any part is not returned within five (5) weeks, a non-refundable invoice will be presented to the customer for the costs of replenishing the exchange parts inventory with a new part. Daktronics reserves the right to refuse parts that have been damaged due to acts of nature or causes other than normal wear and tear.

Repair & Return Program

For items not subject to exchange, Daktronics offers a Repair & Return Program. To send a part for repair, follow these steps:

1. Call Daktronics Customer Service.

United States & Canada: 1-800-DAK-TRON (325-8766)

Outside the U.S. & Canada: +1-605-275-1040

2. Receive a case number before shipping.

This expedites repair of the part.

3. Package and pad the item carefully to prevent damage during shipment.

Electronic components, such as printed circuit boards, should be placed in an antistatic bag before boxing. Daktronics does not recommend using packing peanuts when shipping.

4. Enclose:

- name
- address
- phone number
- the case number
- a clear description of symptoms

5. Ship to:

Daktronics Customer Service

[Case #]

201 Daktronics Drive, Dock E

Brookings, SD 57006

Daktronics Warranty & Limitation of Liability

The Daktronics Warranty & Limitation of Liability is located at the end of this manual. The Warranty is independent of Extended Service agreements and is the authority in matters of service, repair, and operation.

This page intentionally left blank.

A Mechanical Drawings

Refer to **Resources (p.2)** for information regarding how to read the drawing number.
Any contract-specific drawings take precedence over these general drawings.

Reference Drawings:

Module Model Descriptions	DWG-129639
Strut Spacing, Horizontal Wall Mounting.....	DWG-129905
End Bracket Attachment, Horizontal Wall Mounting.....	DWG-129906
Horizontal Wall Mounting, Final Steps.....	DWG-129907
Model Configurations, Swim / Track Timing.....	DWG-130101
Model Configurations, Aquatics Multisport	DWG-130102
Caption Layout- 6-Lane Multi-Sport Systems	DWG-130319
Caption Layout- 8-Lane Multi-Sport Systems	DWG-130321
Corner Mount.....	DWG-130508
Vertical Wall Mount	DWG-130545
Caption Layout- 10-Lane Multi-Sport Systems	DWG-130801
Caption Module Detail.....	DWG-130840
Beam Mounting Procedure.....	DWG-194664
Beam Mounting, Side View	DWG-194671
Mechanical Specifications, 1-Line Digit Module	DWG-194673
Beam Mounting, Top View	DWG-194674
Mechanical Specifications, Ad Panels	DWG-194676
Beam Mounting, Rear View, Vertical Display.....	DWG-194677
Beam Mounting, Rear View, Horizontal Display.....	DWG-194678
Mechanical Specifications, 2-Line Digit Module	DWG-194679
SW-3104 Floor Stand Assy.....	DWG-253540

This page intentionally left blank.

CAPTION MODULE

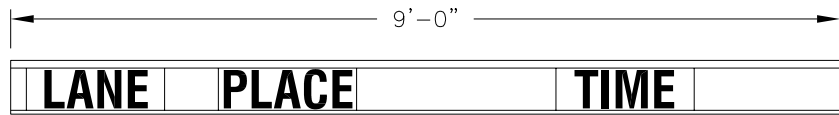

0'-7"

SW-2001
1-LINE TIMING

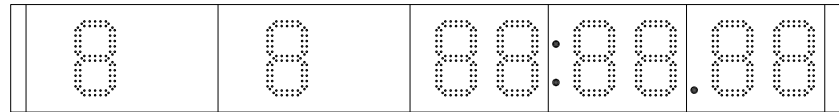

1'-2"

SW-2002
2-LINE TIMING
SW-2002

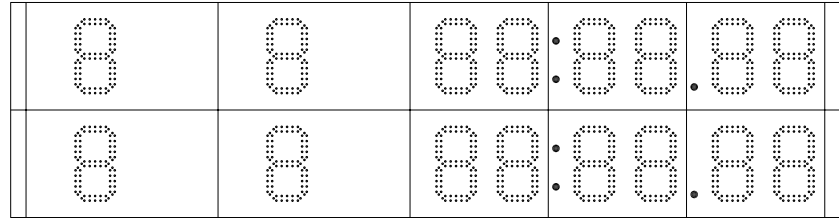

2'-4"

SW-2003
1-LINE TIMING/
MULTISPORT

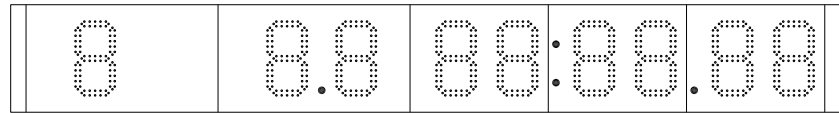

SW-2004
1-LINE SCORING

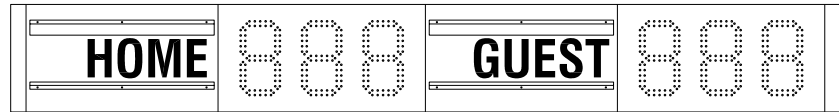

SW-2005
2-LINE SCORING

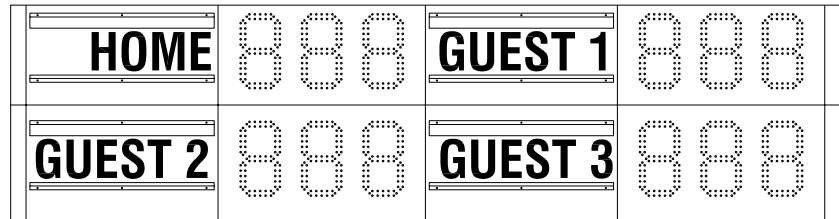

SW-2006
1-LINE
EVENT/HEAT

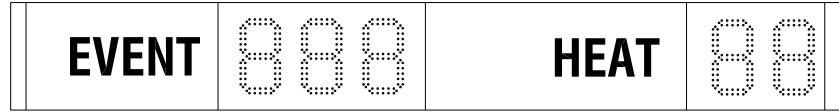

SW-2007
1-LINE
RECORD TIME



CAPTION MODULE

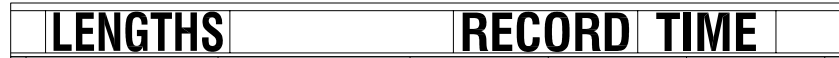

SW-2008
1-LINE LENGTHS/
RECORD TIME



SW-2009
ADDITIONAL SCORING



POWER REQUIREMENT: APPROXIMATELY 100 WATTS MAX PER MODULE

1-LINE MODULE WEIGHS ABOUT 45 LBS
2-LINE MODULE WEIGHS ABOUT 80 LBS

04	02 JUN 03	CHANGED DIGIT PATTERN TO G3	MGL	THE CONCEPTS EXPRESSED AND DETAILS SHOWN ON THIS DRAWING ARE CONFIDENTIAL AND PROPRIETARY. DO NOT REPRODUCE BY ANY MEANS, INCLUDING ELECTRONICALLY WITHOUT THE EXPRESSED WRITTEN CONSENT OF DAKTRONICS, INC. COPYRIGHT 2003 DAKTRONICS, INC. DAKTRONICS, INC. BROOKINGS, SD 57006 PROJ: LED AQUATICS / TRACK DISPLAYS TITLE: MODULE MODEL DESCRIPTIONS DES. BY: AVB DRAWN BY: A VANBEMMEL DATE: 27 MAR 00
03	15 JAN 02	CHANGED DIGIT PATTERN	ALG	
02	02 MAR 01	ADDED CAPTION MODULE TO SW-2008.	AVB	
01	11 APR 00	ADDED MODEL SW-2009	AVB	
REV.	DATE	DESCRIPTION	BY	

REVISION	APPR. BY:	1153-R08A-129639
04	SCALE: 1=25	

REV.	DATE	DESCRIPTION	BY	APPR.

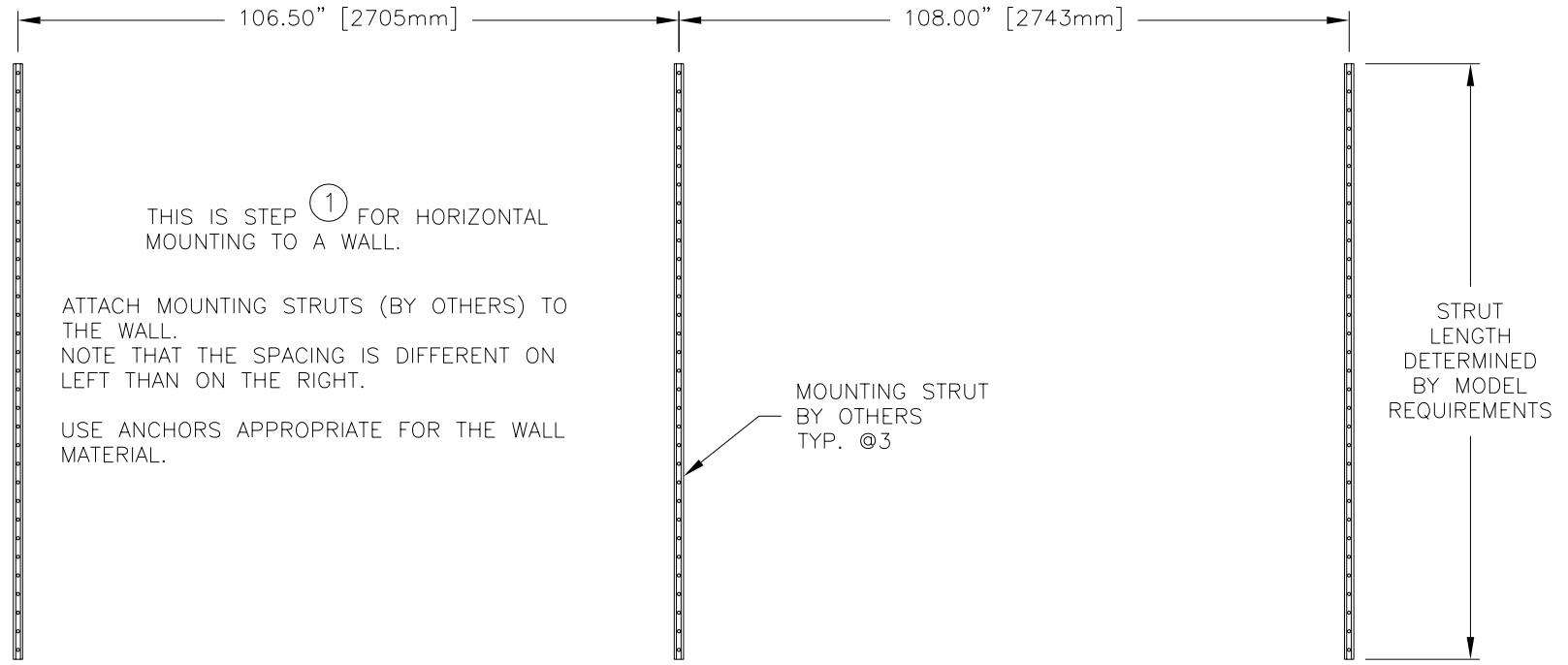

TYPICAL STRUT LENGTHS FOR STANDARD MODELS:

MODEL NO.	DESCRIPTION	DISPLAY HEIGHT	STRUT LENGTH
SW-2116	6-LANE TIMING	49" [1245mm]	36" [900mm]
SW-2118	8-LANE TIMING	63" [1600mm]	48" [1250mm]
SW-2120	10-LANE TIMING	77" [1956mm]	66" [1700mm]
SW-2216	6-LANE MULTISPORT	56" [1422mm]	36" [900mm]
SW-2218	8-LANE MULTISPORT	70" [1778mm]	48" [1250mm]
SW-2220	10-LANE MULTISPORT	84" [2134mm]	66" [1700mm]

CAPTION MODULES MOUNT TO THE ADJACENT DIGIT MODULE AND DO NOT REQUIRE EXTRA STRUT LENGTH WHEN THEY ARE MOUNTED AT THE TOP OR BOTTOM OF THE COLUMN.

AUXILIARY SCORING MODULES OR AD PANELS WILL REQUIRE ADDITIONAL STRUT LENGTH.

INSTALLING AN OPTIONAL MESSAGE CENTER IS SIMILAR, BUT REQUIRES DIFFERENT STRUT SPACING.

SEE DRAWINGS 1153-R10A-129906 AND 1153-R10A-129907 FOR OTHER STEPS IN HORIZONTAL WALL MOUNTING.

DAKTRONICS, INC. BROOKINGS, SD 57006	
PROJ: LED AQUATICS / TRACK DISPLAYS	
TITLE: STRUT SPACING, HORIZONTAL WALL MOUNTING	
DES. BY: AVB	DRAWN BY: A VANBEMMEL
DATE: 23 MAR 00	
REVISION	APPR. BY:
SCALE: 1=30	1153-R10A-129905

THIS IS STEP ② FOR HORIZONTAL MOUNTING TO A WALL.

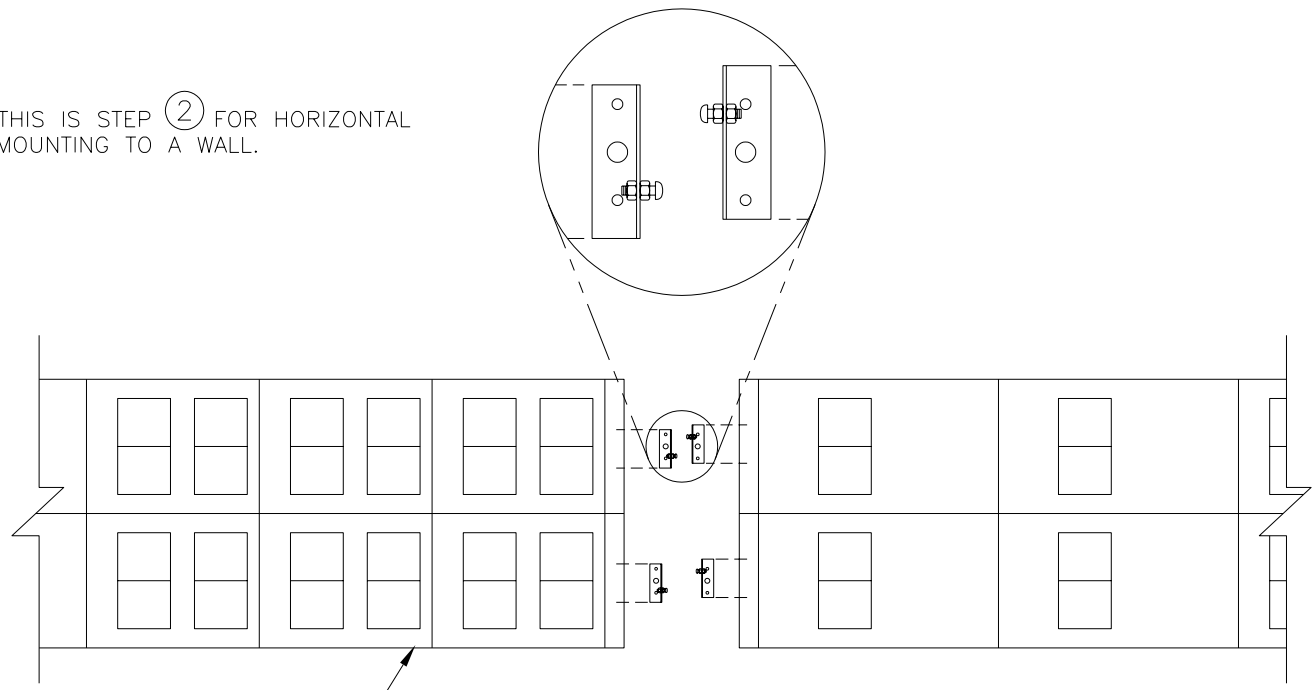

2-LINE MODULE

ATTACH END BRACKETS TO THE END OF EACH OF THE MODULES, ON THE END THAT WILL BE UP AGAINST THE OTHER COLUMN OF MODULES.

1-LINE MODULES USE ONE BRACKET.
2-LINE MODULES USE TWO BRACKETS.

SEE DRAWINGS 1153-R10A-129905 AND 1153-R10A-129907 FOR OTHER STEPS IN HORIZONTAL WALL MOUNTING.

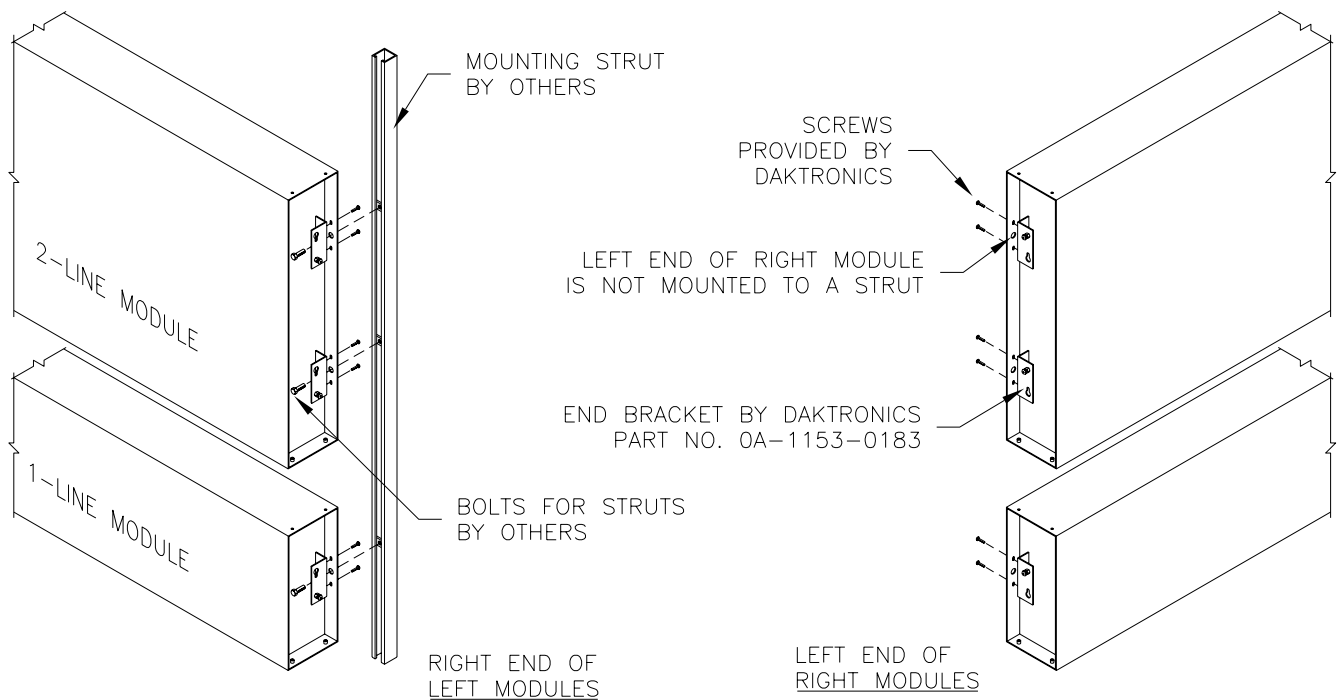

DAKTRONICS, INC. BROOKINGS, SD 57006	
PROJ: LED AQUATICS / TRACK DISPLAYS	
TITLE: END BRACKET ATTACHMENT, HORIZONTAL WALL MOUNTING	
DES. BY: AVB	DRAWN BY: A VANBEMMEL DATE: 23 MAR 00
REVISION	APPR. BY: _____
	SCALE: 1=20
1153-R10A-129906	

REV.	DATE	DESCRIPTION	BY	APPR.

REV.	DATE	DESCRIPTION	BY	APPR.
------	------	-------------	----	-------

THIS IS STEP ③ FOR HORIZONTAL MOUNTING TO A WALL.

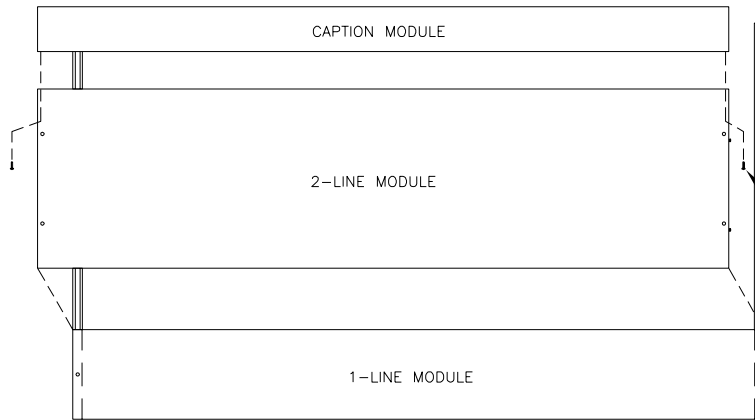

INSTALL THE MODULES IN THE LEFT COLUMN BY JOINING THE MOUNTING HOLES IN THE BACK OF EACH MODULE TO THE MOUNTING STRUT. START AT THE BOTTOM AND WORK UP.

CAPTION MODULES ATTACH TO THE ADJACENT DIGIT MODULE AND DO NOT NEED TO BE ATTACHED TO THE STRUTS.

MOUNTING STRUT BY OTHERS TYP. @3

STARTING AT THE BOTTOM, INSTALL THE MODULES IN THE RIGHT COLUMN.

STEP ④

JOIN THE END BRACKETS BY INSERTING THE SCREW HEADS INTO THE KEYHOLES IN THE MATING BRACKET, THEN PRESS DOWN.

ATTACH THE RIGHT END OF EACH MODULE TO THE MOUNTING STRUT.

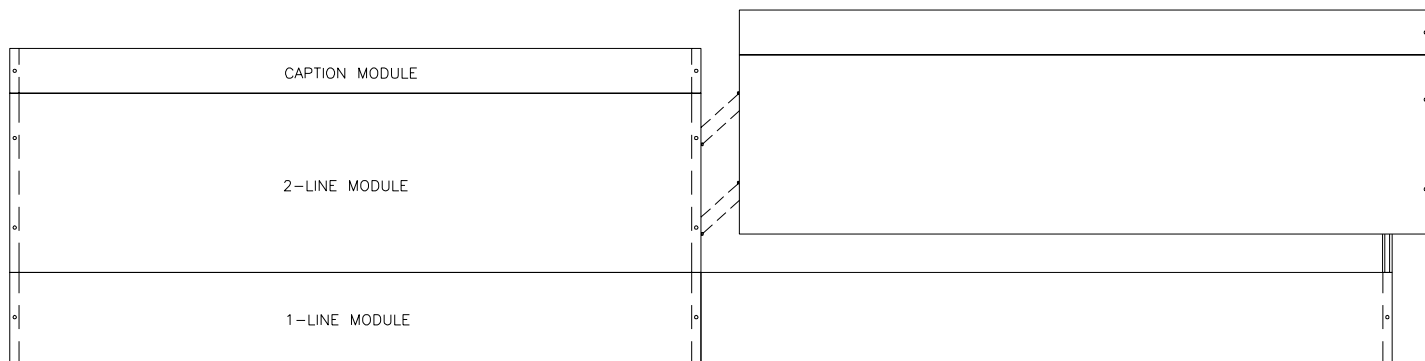

SEE DRAWINGS 1153-R10A-129905 AND 1153-R10A-129906 FOR OTHER STEPS IN HORIZONTAL WALL MOUNTING.

PROJ:	LED AQUATICS / TRACK DISPLAYS
TITLE:	HORIZONTAL WALL MOUNTING, FINAL STEPS
DES. BY:	AVB
DRAWN BY:	A VANBEMMEL
DATE:	23 MAR 00
REVISION	
APPR. BY:	
SCALE:	1=30
DAKTRONICS, INC. BROOKINGS, SD 57006	
1153-R10A-129907	

SWIM / TRACK TIMING MODELS

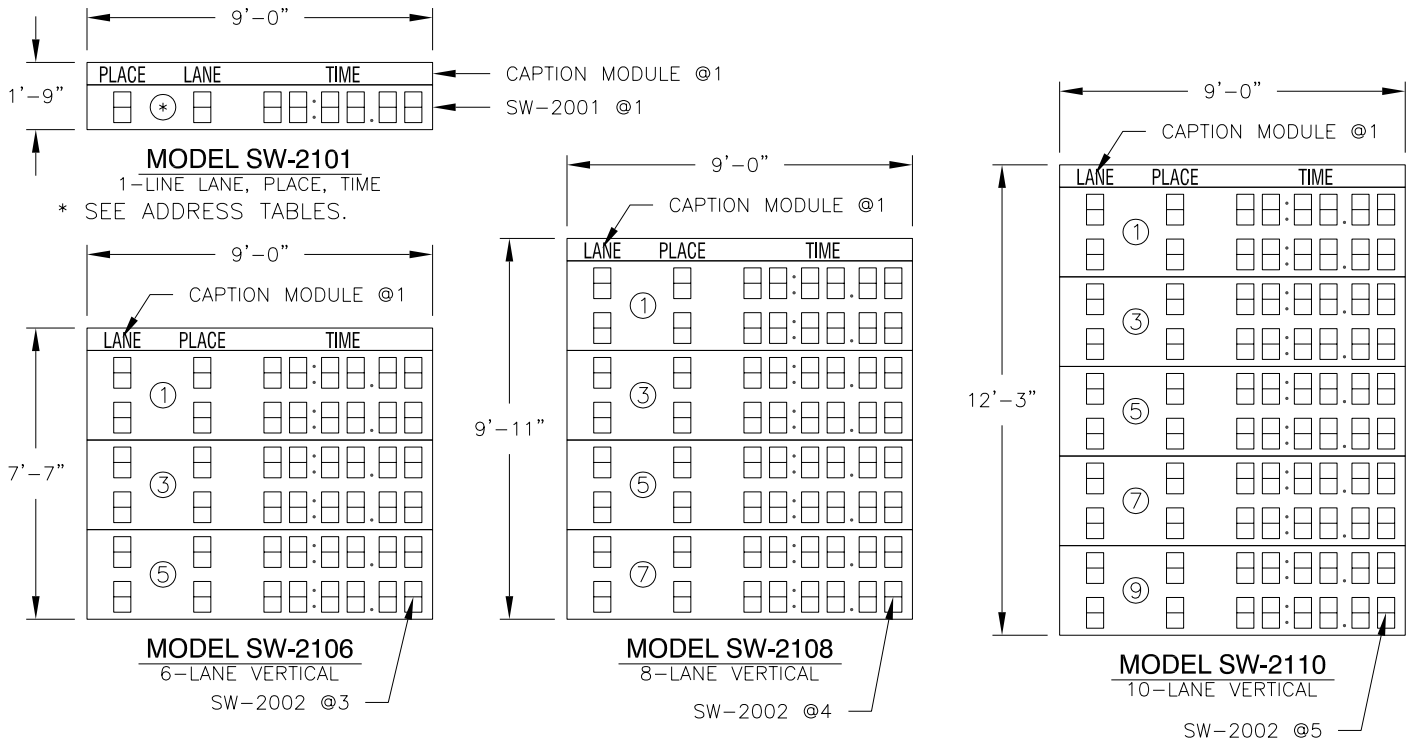

TYPICAL MODULE DIMENSIONS:

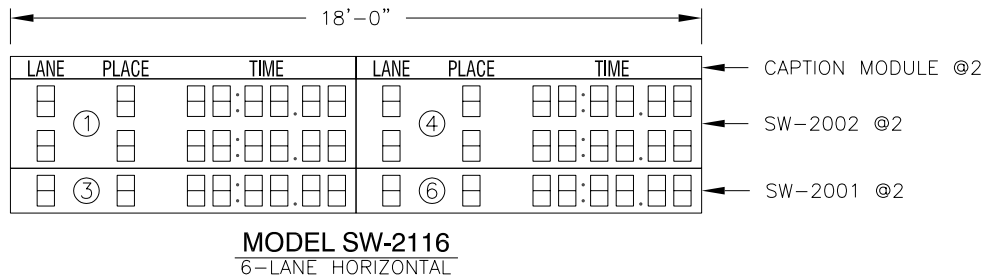
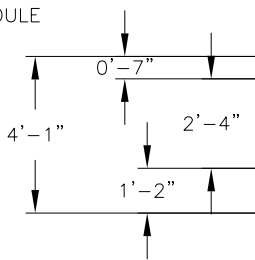

MODEL NUMBERING NOTES:

MODEL NUMBERS FOR INDIVIDUAL MODULES ARE SW-2000 SERIES.

MODEL NUMBERS FOR MULTILINE MODELS ARE SW-2100 SERIES.

EACH MODEL NUMBER ALSO HAS A SUFFIX NUMBER AS FOLLOWS:
 -11 OUTDOOR 120V
 -12 OUTDOOR 230V
 -13 INDOOR 120V
 -14 INDOOR 230V

NOT ALL ADDRESSES ARE SUPPORTED BY ALL CONTROLLERS. SEE ADDRESS TABLES.

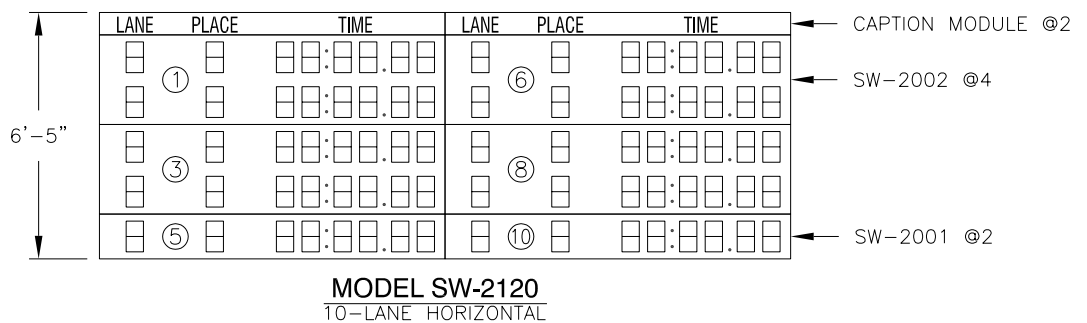
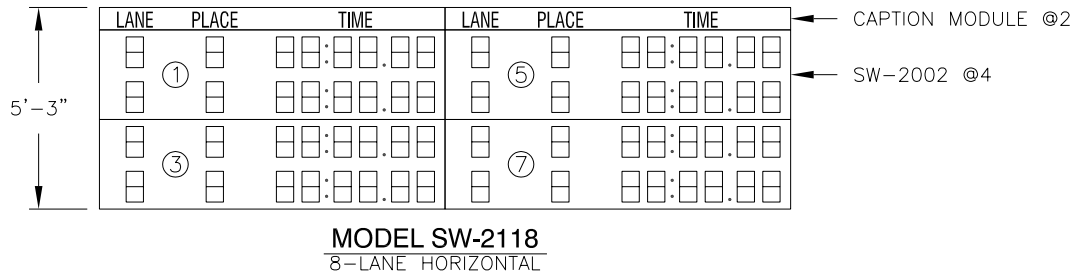

REV.	DATE	DESCRIPTION	BY	APPR.
03	12 FEB 03	SWITCHED LANE AND PLACE CAPTIONS AROUND ON MODEL SW-2101.	JJS	
02	25 JUL 02	CHANGED MODEL SUFFIX NUMBERS -9 & -10 TO -13 & -14 FOR INDOOR DISPLAYS.	AVB	
01	14 AUG 00	ADDED ADDRESS LABELS.	JAS	

DAKTRONICS, INC. BROOKINGS, SD 57006			
PROJ: LED AQUATICS / TRACK SCOREBOARDS			
TITLE: MODEL CONFIGURATIONS, SWIM / TRACK TIMING			
DES. BY:		DRAWN BY: A VANBEMMEL	
		DATE: 27 MAR 00	
REVISION	APPR. BY:	1153-R08A-130101	
03	SCALE: 1=60		

AQUATICS MULTISPORT MODELS

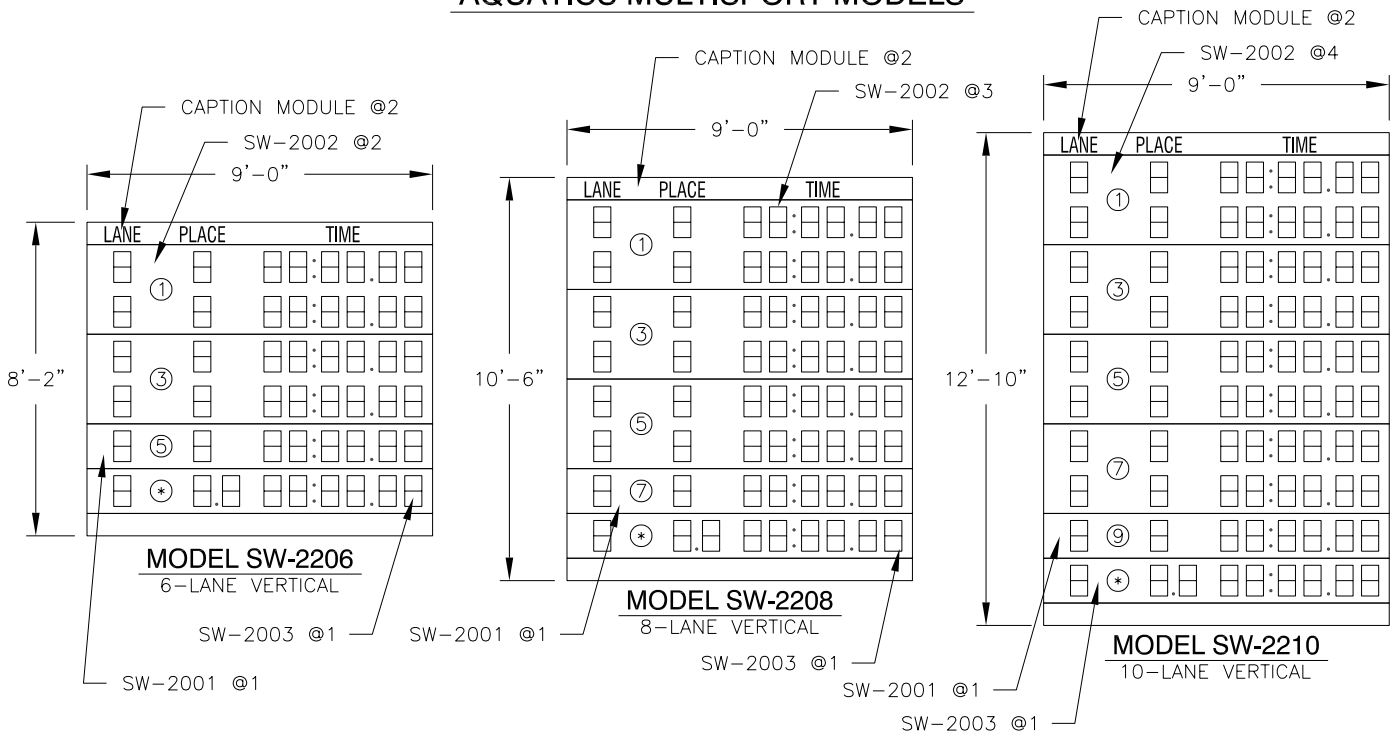

TYPICAL MODULE DIMENSIONS:

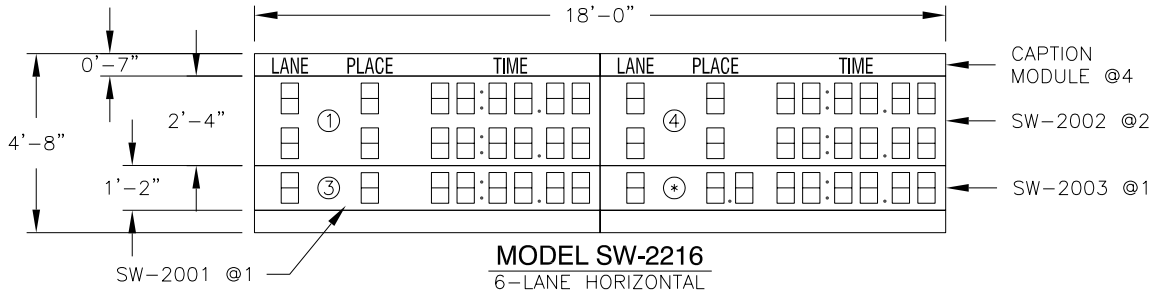

MODEL NUMBERING NOTES:

MODEL NUMBERS FOR INDIVIDUAL MODULES ARE SW-2000 SERIES.

MODEL NUMBERS FOR MULTILINE MODELS ARE SW-2200 SERIES.

EACH MODEL NUMBER ALSO HAS A SUFFIX NUMBER AS FOLLOWS:

- 11 OUTDOOR 120V
- 12 OUTDOOR 230V
- 13 INDOOR 120V
- 14 INDOOR 230V

⊛ ADDRESS FOR SW-2003 MULTISPORT MODULE IS SUPPORTED ONLY BY DAKTRONICS CONTROLLER. SEE ADDRESS TABLES.

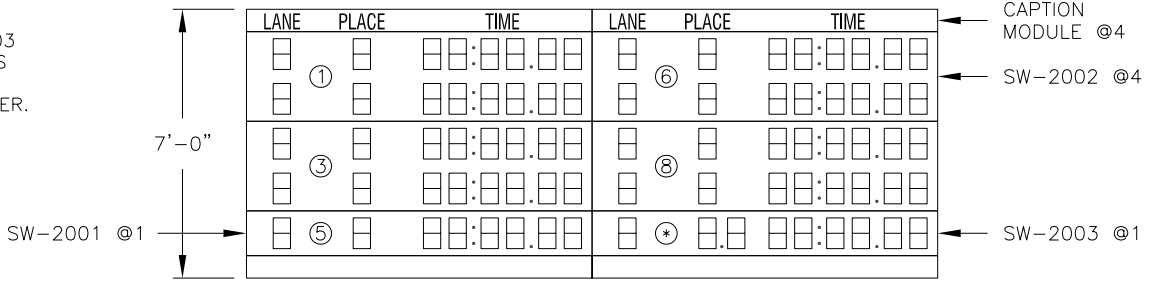
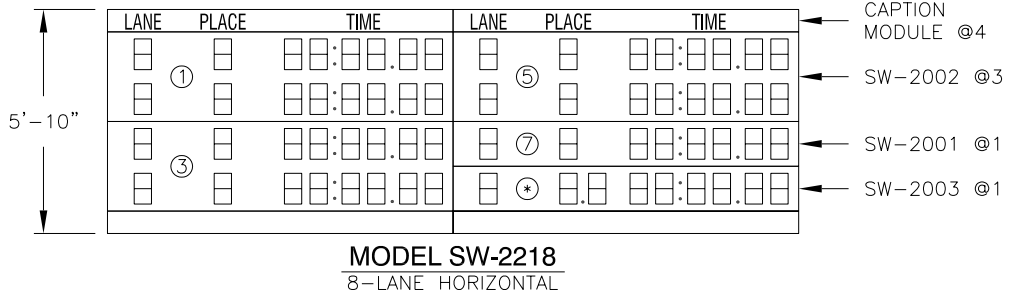

REV.	DATE	DESCRIPTION	BY	APPR.
04	12 FEB 03	MOVED MULTISPORT MODE TO BOTTOM ON MODELS SW-2210 AND SW-2220.	JJS	
03	25 JUL 02	CHANGED MODEL SUFFIX NUMBERS -9 & -10 TO -13 & -14 FOR INDOOR DISPLAYS.	AVB	
02	08 AUG 00	MOVED SW-2001 UP TO LINE 8 ON SW-2220; ADDED ADDRESS LABELS.	JAS	
01	08 MAY 00	CORRECTED MODULE MODEL NUMBERS ON MODEL SW-2210	AVB	

DAKTRONICS, INC. BROOKINGS, SD 57006

PROJ: LED AQUATICS / TRACK SCOREBOARDS

TITLE: MODEL CONFIGURATIONS, AQUATICS MULTISPORT

DES. BY: DRAWN BY: A VANBEMMEL DATE: 27 MAR 00

REVISION	APPR. BY:	1153-R08A-130102
04	SCALE: 1=60	

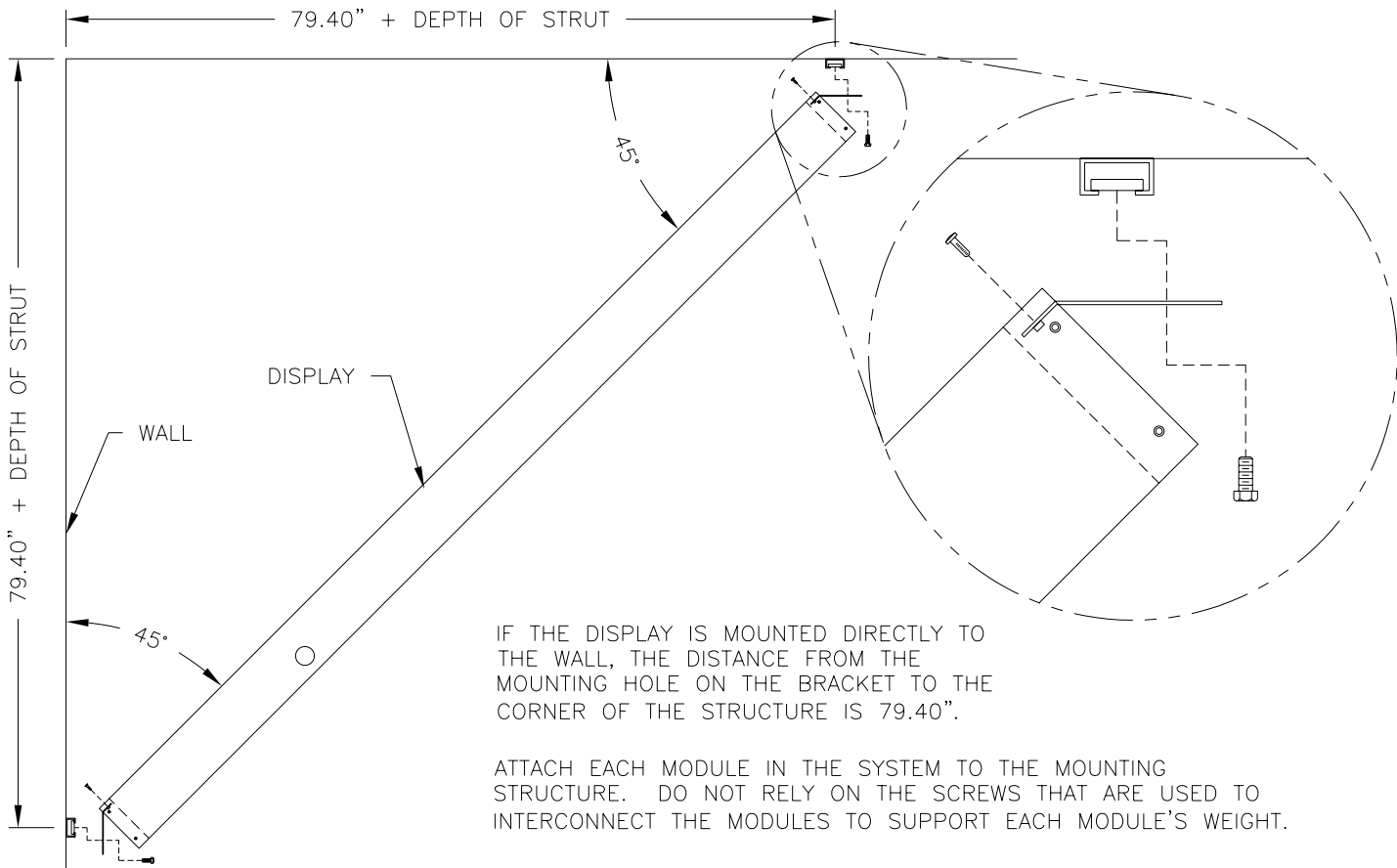

IF THE DISPLAY IS MOUNTED DIRECTLY TO THE WALL, THE DISTANCE FROM THE MOUNTING HOLE ON THE BRACKET TO THE CORNER OF THE STRUCTURE IS 79.40".

ATTACH EACH MODULE IN THE SYSTEM TO THE MOUNTING STRUCTURE. DO NOT RELY ON THE SCREWS THAT ARE USED TO INTERCONNECT THE MODULES TO SUPPORT EACH MODULE'S WEIGHT.

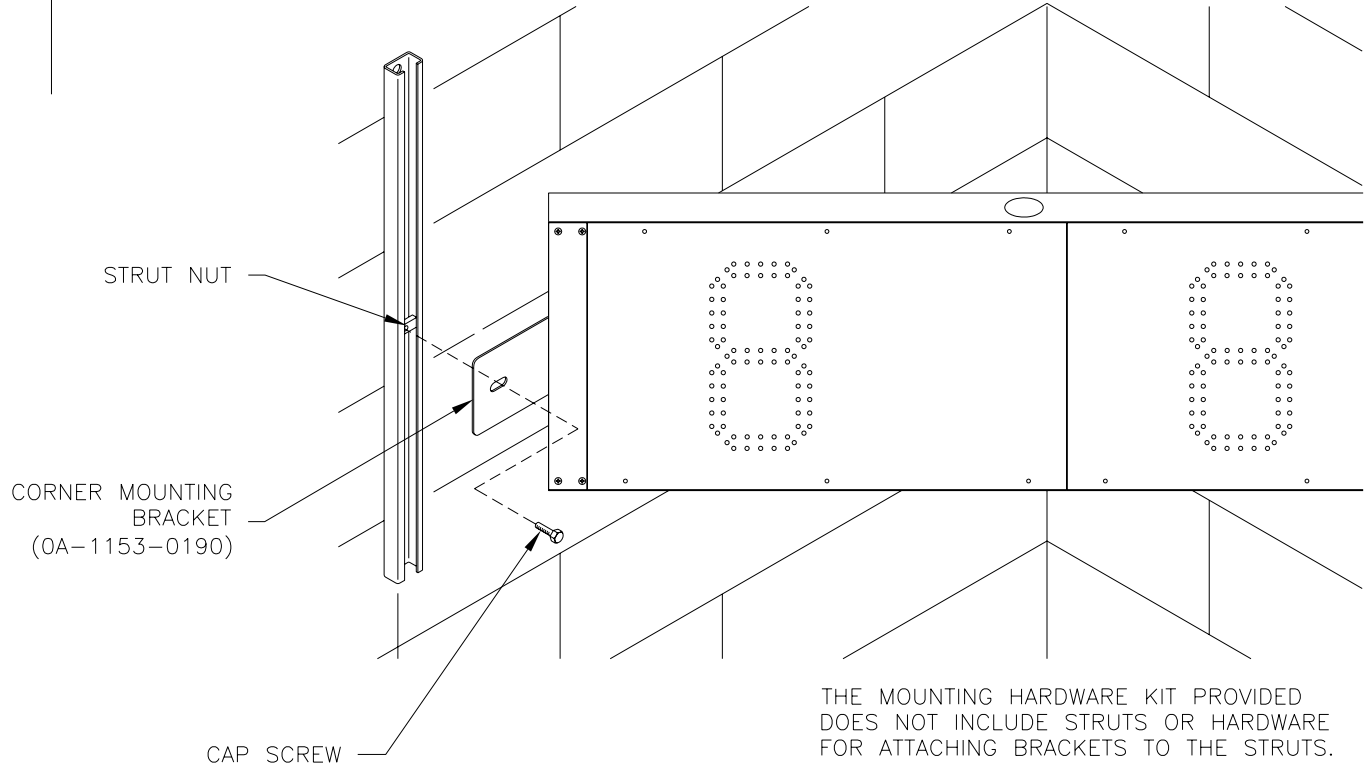

THE MOUNTING HARDWARE KIT PROVIDED DOES NOT INCLUDE STRUTS OR HARDWARE FOR ATTACHING BRACKETS TO THE STRUTS.

THE CONCEPTS EXPRESSED AND DETAILS SHOWN ON THIS DRAWING ARE CONFIDENTIAL AND PROPRIETARY. DO NOT REPRODUCE BY ANY MEANS, INCLUDING ELECTRONICALLY WITHOUT THE EXPRESSED WRITTEN CONSENT OF DAKTRONICS, INC. COPYRIGHT 2003 DAKTRONICS, INC.

REV.	DATE	DESCRIPTION	BY	APPR.
03	16 JUL 04	CORRECTED PART NUMBER OF 0A-1153-0190.	AVB	
02	02 JUN 03	CHANGED DIGIT PATTERN TO G3	MGL	
01	15 JAN 02	CHANGED DIGIT PATTERN	ALG	

DAKTRONICS, INC. BROOKINGS, SD 57006	
PROJ: LED AQUATICS / TRACK DISPLAYS	
TITLE: CORNER MOUNT	
DES. BY: AVB	DRAWN BY: DWEIBEL
DATE: 05 APR 00	
REVISION	APPR. BY:
03	SCALE: NONE
1153-R04A-130508	

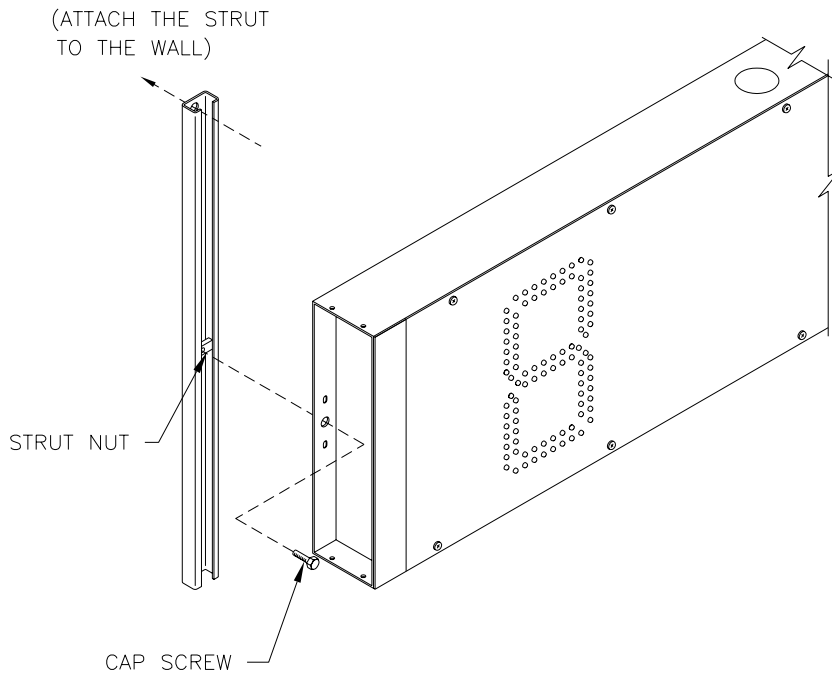
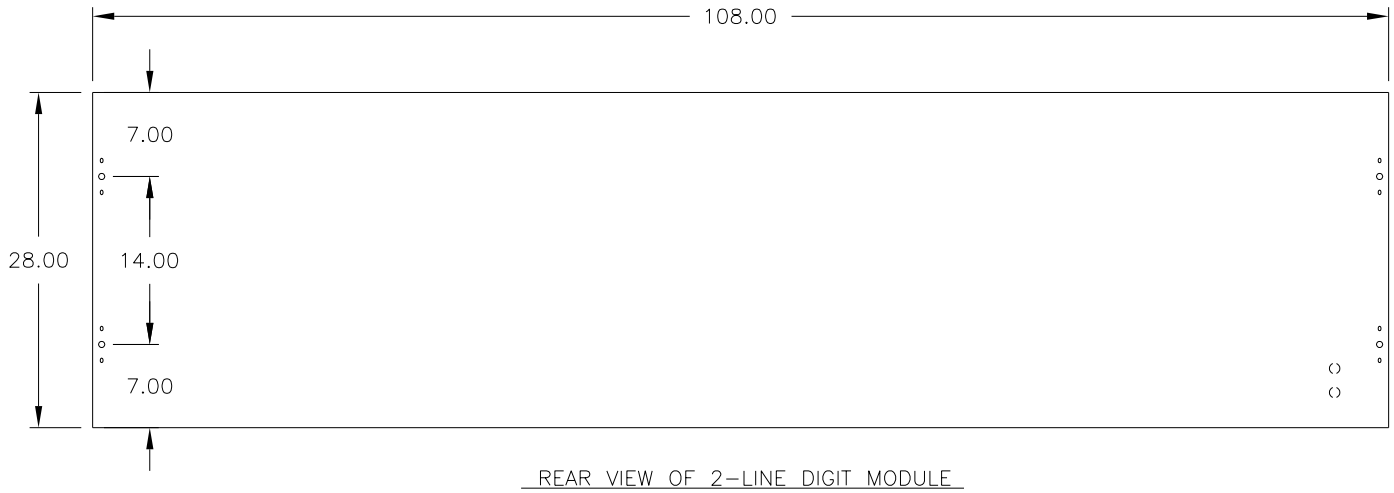
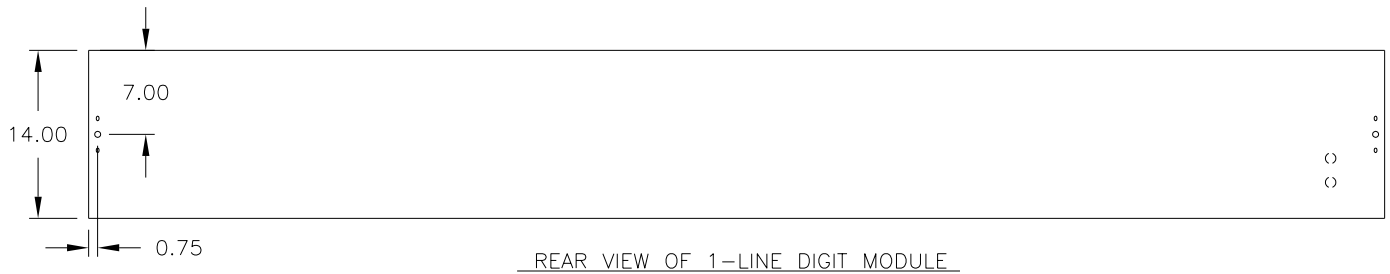

SELECT THE WALL ANCHOR METHOD BEST SUITED TO THE FACILITY.

START WITH THE LOWEST MODULE IN THE SYSTEM, AND WORK UP.

MOUNTING HARDWARE SHOWN IS NOT PROVIDED BY DAKTRONICS.

MOUNT THE DIGIT MODULES TO EITHER UNIVERSAL CHANNEL STRUT (AS SHOWN), A MOUNTING STRUCTURE, OR DIRECTLY TO A WALL.

THE CONCEPTS EXPRESSED AND DETAILS SHOWN ON THIS DRAWING ARE CONFIDENTIAL AND PROPRIETARY. DO NOT REPRODUCE BY ANY MEANS, INCLUDING ELECTRONICALLY WITHOUT THE EXPRESSED WRITTEN CONSENT OF DAKTRONICS, INC. COPYRIGHT 2002 DAKTRONICS, INC.			
DAKTRONICS, INC. BROOKINGS, SD 57006			
PROJ: LED AQUATICS / TRACK DISPLAYS			
TITLE: VERTICAL WALL MOUNT			
DES. BY: AVB		DRAWN BY: DWEIBEL	
		DATE: 13 APR 00	
REVISION	APPR. BY:	1153-R04A-130545	
	SCALE: NONE		

REV.	DATE	DESCRIPTION	BY	APPR.

INSERT THE TOP OF THE CAPTION PANEL INTO THE UPPER GUIDE IN THE MODULE. LIFT, PRESS BACK, AND DROP INTO THE BOTTOM GUIDE

CAPTION MODULE
7" HIGH

DIGIT MODULE
14" OR 28" HIGH

ATTACH THE CAPTION MODULE TO THE TOP OR BOTTOM OF THE ADJACENT DIGIT MODULE, USING THE #10 SCREWS PROVIDED.

NOTE THAT THE UPPER GUIDE IS DEEPER THAN THE BOTTOM GUIDE.

BE SURE THAT THE MODULE IS ORIENTED CORRECTLY WHEN INSTALLING.

DAKTRONICS, INC. BROOKINGS, SD 57006	
PROJ: LED AQUATICS/TRACK DISPLAYS	
TITLE: CAPTION MODULE DETAIL	
DES. BY: AVB	DRAWN BY: A VANBEMMEL DATE: 12 APR 00
REVISION	APPR. BY: _____
	SCALE: 1=8
1153-R10A-130840	

REV.	DATE	DESCRIPTION	BY	APPR.

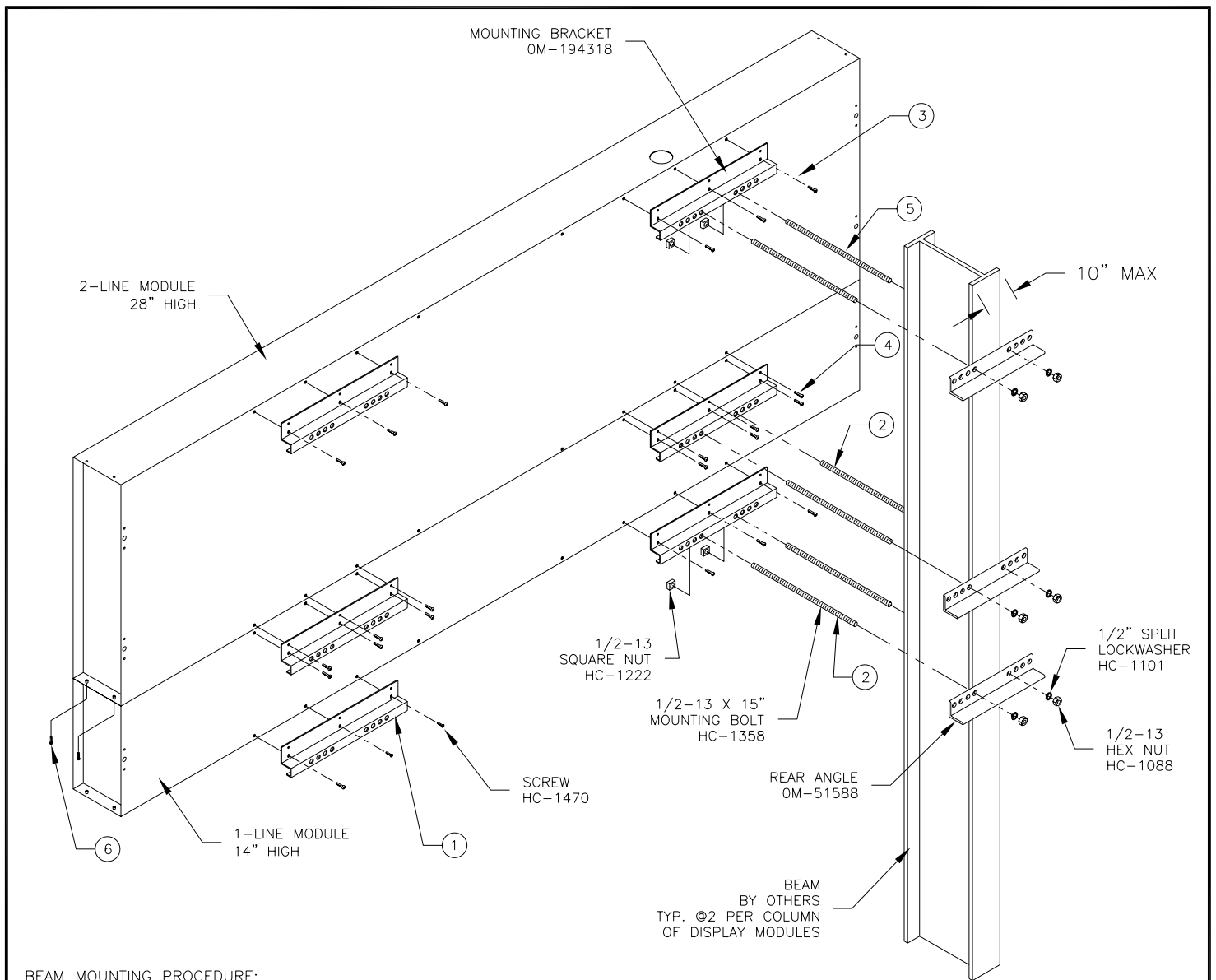

BEAM MOUNTING PROCEDURE:

THE CIRCLED NUMBERS IN THE DRAWING REFER TO THE STEPS OF THIS PROCEDURE.

ONLY ONE BEAM IS SHOWN, TWO BEAMS REQUIRED FOR EACH COLUMN OF DISPLAY MODULES. BEAMS MUST BE SET 4'-6" APART, CENTER TO CENTER.

1. ATTACH MOUNTING BRACKETS TO THE TOP AND BOTTOM OF THE LOWEST DISPLAY MODULE IN THE SYSTEM BY INSERTING SCREWS THROUGH THE HOLES IN THE BRACKET AND THREADING INTO THE CAPTIVATED NUTS IN THE BACK OF THE MODULE.
2. POSITION THAT MODULE AGAINST THE BEAMS AND SECURE TO THE BEAM WITH THE BOLTS, WASHERS, AND NUTS PROVIDED. THE SQUARE NUTS GO INSIDE THE BRACKET, AND THE HEX NUTS AND WASHERS ARE USED INSIDE THE REAR ANGLE AT THE BACK OF THE BEAM. USE A 3/4" SOCKET TO TIGHTEN. **CAUTION:** DO NOT OVERTIGHTEN AND DEFORM THE BRACKET OR ANGLES.
3. ATTACH THE UPPER MOUNTING BRACKET TO THE NEXT MODULE AND SET IT ON TOP OF THE FIRST MODULE.
4. INSTALL SCREWS THROUGH THE BRACKET TO SECURE THE BOTTOM OF THE SECOND MODULE.
5. SECURE THE UPPER BRACKET TO THE BEAMS WITH THE BOLTS, WASHERS, AND NUTS.
6. ATTACH THE MODULES TOGETHER AT THE ENDS BY INSERTING SCREWS UP THROUGH THE HOLES IN THE TOP OF THE LOWER MODULE INTO THE CAPTIVATED NUTS IN THE BOTTOM OF THE UPPER MODULE.
7. CONTINUE BUILDING UP IN THIS MANNER FOR ANY REMAINING MODULES IN THE SYSTEM. CAPTION MODULES ARE ATTACHED ONLY TO THE ADJACENT DIGIT MODULES, AND DO NOT ACCEPT BEAM MOUNTING BRACKETS.

SEE DRAWING 1153-R10A-194671 FOR A SIDE VIEW AND DETAILS.

THE CONCEPTS EXPRESSED AND DETAILS SHOWN ON THIS DRAWING ARE CONFIDENTIAL AND PROPRIETARY. DO NOT REPRODUCE BY ANY MEANS, INCLUDING ELECTRONICALLY WITHOUT THE EXPRESSED WRITTEN CONSENT OF DAKTRONICS, INC. COPYRIGHT 2003 DAKTRONICS, INC.			
DAKTRONICS, INC. BROOKINGS, SD 57006			
PROJ: LED AQUATICS SCOREBOARDS			
TITLE: BEAM MOUNTING PROCEDURE			
DES. BY: A VANBEMMEL		DRAWN BY: M LEOPOLD	DATE: 11 AUG 03
REVISION	APPR. BY:	1153-R10A-194664	
00	SCALE: 1=20		

REV.	DATE	DESCRIPTION	BY	APPR.

A TYPICAL INSTALLATION MAY BE MADE UP OF 1- & 2-LINE MODULES AND CAPTION MODULES. THEIR SPECIFIC LOCATIONS ARE DETERMINED BY THE SYSTEM SPECIFICATIONS. ONLY ONE OF EACH IS SHOWN HERE.

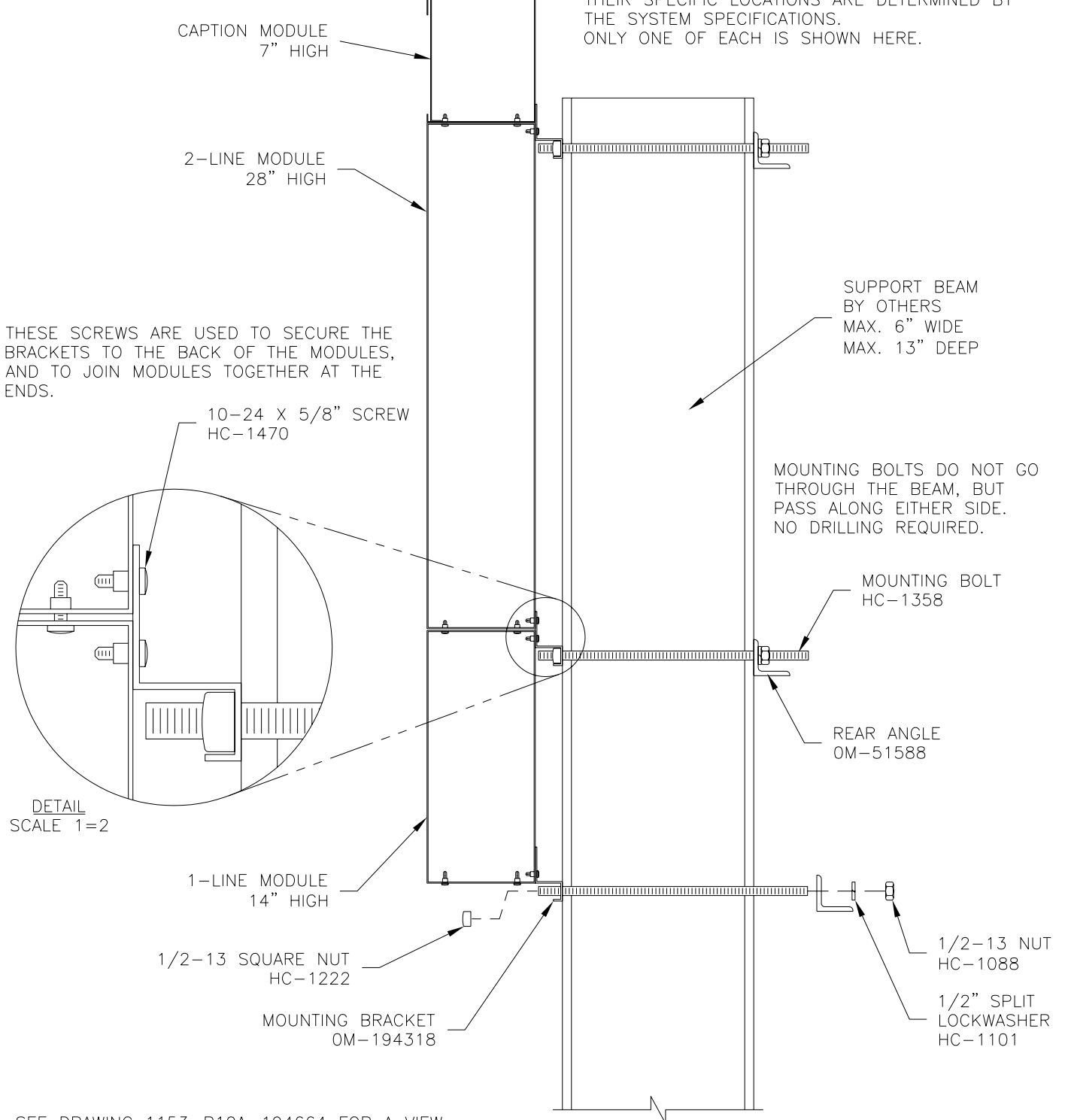

THESE SCREWS ARE USED TO SECURE THE BRACKETS TO THE BACK OF THE MODULES, AND TO JOIN MODULES TOGETHER AT THE ENDS.

10-24 X 5/8" SCREW
HC-1470

SUPPORT BEAM
BY OTHERS
MAX. 6" WIDE
MAX. 13" DEEP

MOUNTING BOLTS DO NOT GO THROUGH THE BEAM, BUT PASS ALONG EITHER SIDE. NO DRILLING REQUIRED.

MOUNTING BOLT
HC-1358

REAR ANGLE
OM-51588

DETAIL
SCALE 1=2

1-LINE MODULE
14" HIGH

1/2-13 SQUARE NUT
HC-1222

MOUNTING BRACKET
OM-194318

1/2-13 NUT
HC-1088

1/2" SPLIT
LOCKWASHER
HC-1101

SEE DRAWING 1153-R10A-194664 FOR A VIEW FROM THE REAR OF THE DISPLAY, AND STEP BY STEP PROCEDURE.

SIDE VIEW

THE CONCEPTS EXPRESSED AND DETAILS SHOWN ON THIS DRAWING ARE CONFIDENTIAL AND PROPRIETARY. DO NOT REPRODUCE BY ANY MEANS, INCLUDING ELECTRONICALLY WITHOUT THE EXPRESSED WRITTEN CONSENT OF DAKTRONICS, INC. COPYRIGHT 2003 DAKTRONICS, INC.			
DAKTRONICS, INC. BROOKINGS, SD 57006			
PROJ: LED AQUATICS SCOREBOARDS			
TITLE: BEAM MOUNTING, SIDE VIEW			
DES. BY: A VANBEMMEL		DRAWN BY: M LEOPOLD	DATE: 11 AUG 03
REVISION	APPR. BY:	1153-R10A-194671	
00	SCALE: 1=8		

REV.	DATE	DESCRIPTION	BY	APPR.

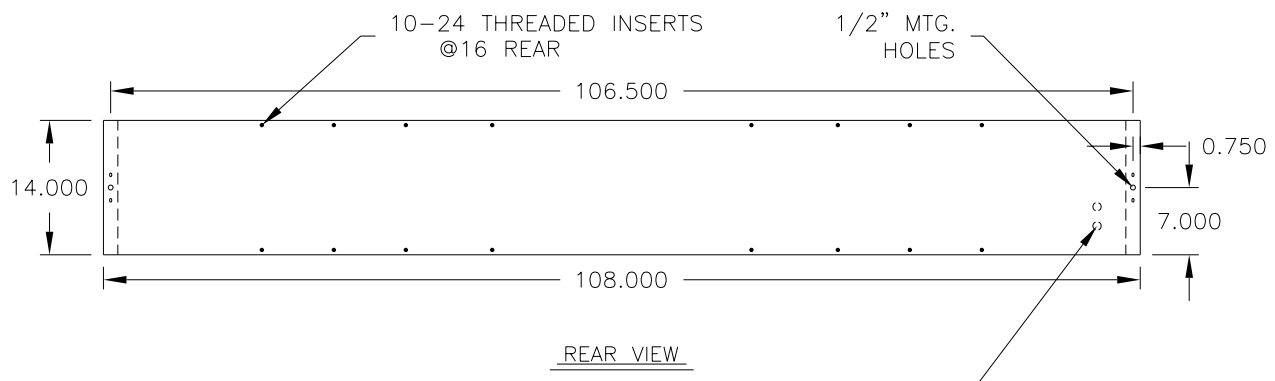
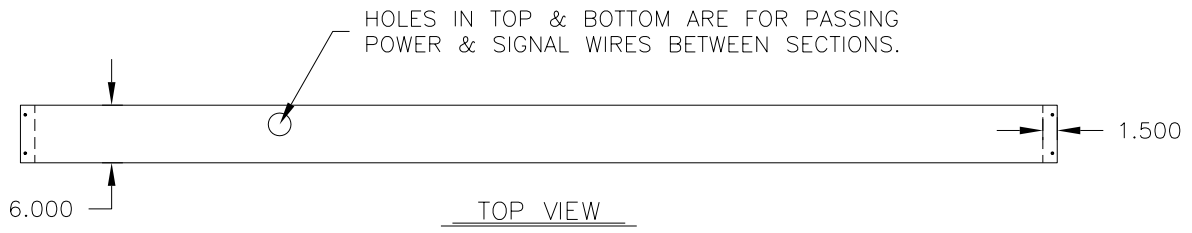

KNOCKOUTS ON SIDE & REAR MAY BE USED TO ROUTE POWER AND SIGNAL INTO THE DISPLAY.

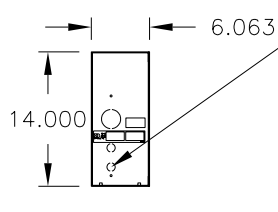

MOUNTING WEIGHT: 45 LBS.
DIMENSIONS: 108" x 14" x 6"

SIDE VIEW
INDOOR MODELS

NOTE: -SEE ELECTRICAL SPECIFICATION DRAWINGS FOR THE FRONT VIEWS OF VARIOUS MODELS.

THE CONCEPTS EXPRESSED AND DETAILS SHOWN ON THIS DRAWING ARE CONFIDENTIAL AND PROPRIETARY. DO NOT REPRODUCE BY ANY MEANS, INCLUDING ELECTRONICALLY WITHOUT THE EXPRESSED WRITTEN CONSENT OF DAKTRONICS, INC. COPYRIGHT 2003 DAKTRONICS, INC.			
DAKTRONICS, INC. BROOKINGS, SD 57006			
PROJ: LED AQUATICS SCOREBOARDS			
TITLE: MECHANICAL SPECIFICATIONS, 1-LINE DIGIT MODULE			
DES. BY: A VANBEMMEL		DRAWN BY: M LEOPOLD	DATE: 11 AUG 03
REVISION	APPR. BY:	1153-R04A-194673	
00	SCALE: 1=20		

REV.	DATE	DESCRIPTION	BY	APPR.

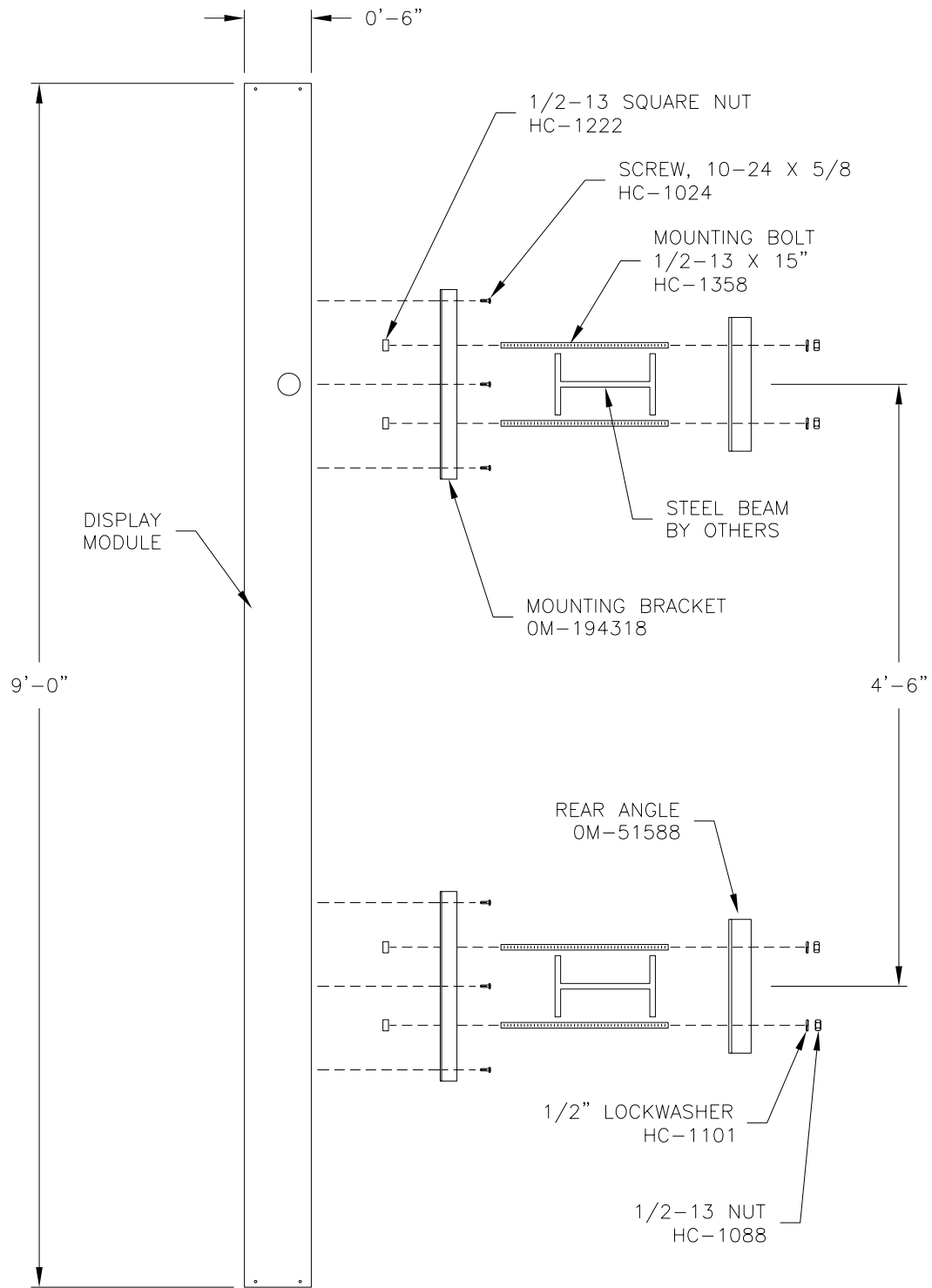

TOP VIEW

THE CONCEPTS EXPRESSED AND DETAILS SHOWN ON THIS DRAWING ARE CONFIDENTIAL AND PROPRIETARY. DO NOT REPRODUCE BY ANY MEANS, INCLUDING ELECTRONICALLY WITHOUT THE EXPRESSED WRITTEN CONSENT OF DAKTRONICS, INC. COPYRIGHT 2003 DAKTRONICS, INC.			
DAKTRONICS, INC. BROOKINGS, SD 57006			
PROJ: LED AQUATICS SCOREBOARDS			
TITLE: BEAM MOUNTING, TOP VIEW			
DES. BY: A VANBEMMEL		DRAWN BY: M LEOPOLD	
		DATE: 11 AUG 03	
REVISION	APPR. BY:	1153-R10A-194674	
00	SCALE: 1=15		

REV.	DATE	DESCRIPTION	BY	APPR.

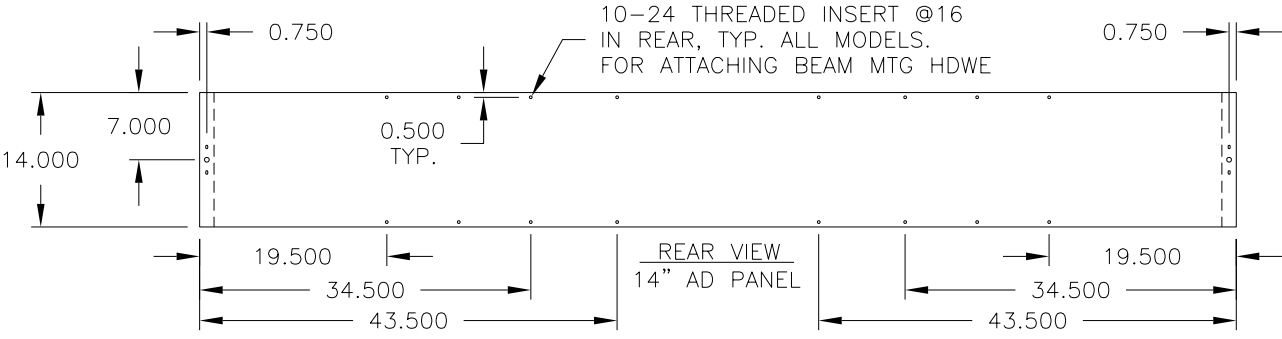
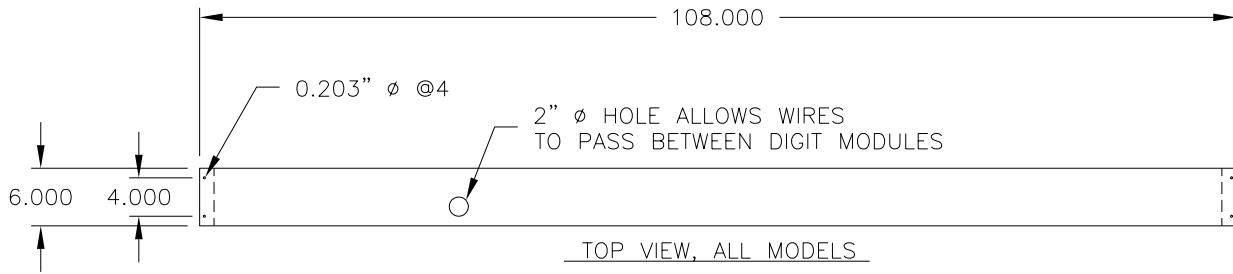

HORIZONTAL DIMENSIONS ARE TYPICAL FOR ALL MODELS

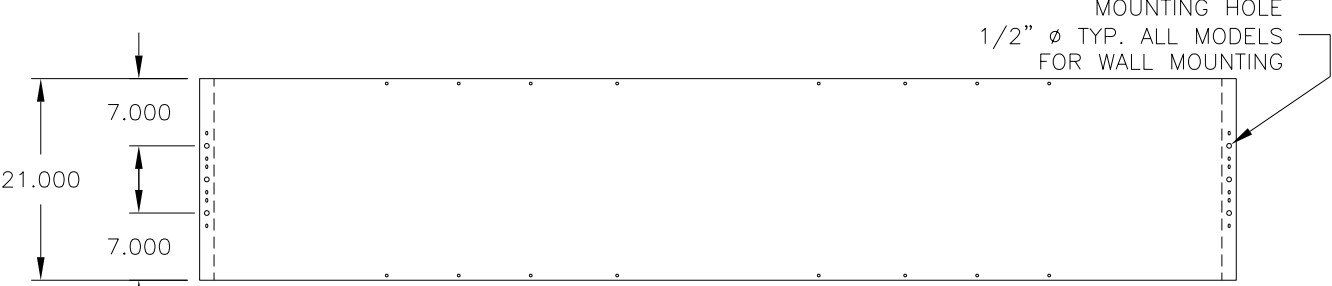

REAR VIEW
21" AD PANEL

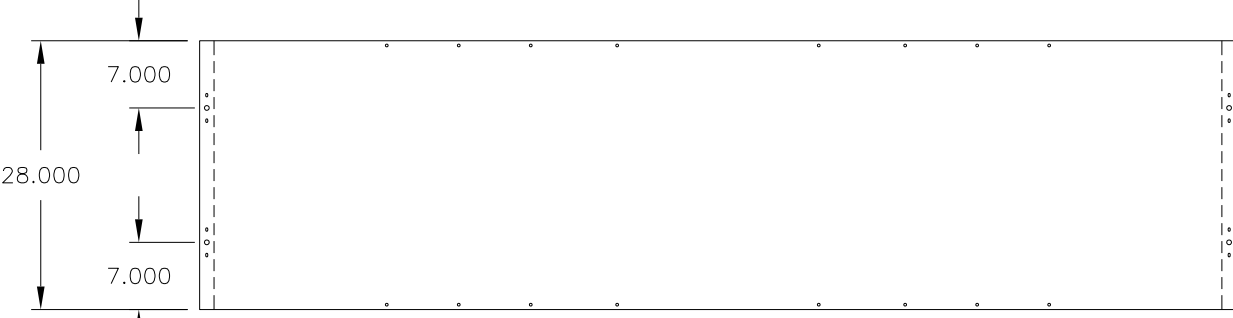

REAR VIEW
28" AD PANEL

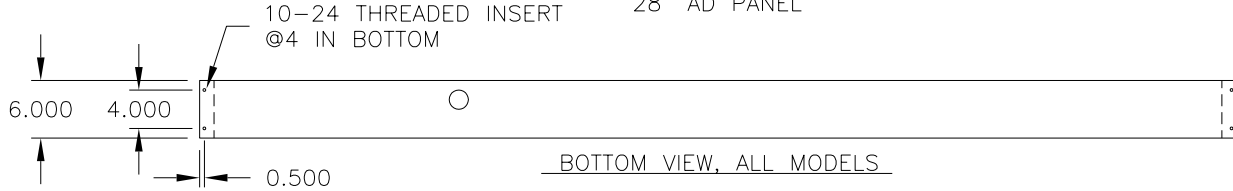

FRONT OF AD PANELS NOT SHOWN. ALL ARE PAINTED ALUMINUM SURFACE ON THE FRONT, WITH NO HOLES. AD COPY MAY BE PAINTED OR VINYL.

THE CONCEPTS EXPRESSED AND DETAILS SHOWN ON THIS DRAWING ARE CONFIDENTIAL AND PROPRIETARY. DO NOT REPRODUCE BY ANY MEANS, INCLUDING ELECTRONICALLY WITHOUT THE EXPRESSED WRITTEN CONSENT OF DAKTRONICS, INC. COPYRIGHT 2003 DAKTRONICS, INC.

DAKTRONICS, INC. BROOKINGS, SD 57006

PROJ: LED AQUATICS SCOREBOARDS

TITLE: MECHANICAL SPECIFICATIONS, AD PANELS

DES. BY: A VANBEMMEL

DRAWN BY: M LEOPOLD

DATE: 11 AUG 03

REVISION
00

APPR. BY:
SCALE: 1=20

1153-R08A-194676

REV.	DATE	DESCRIPTION	BY	APPR.

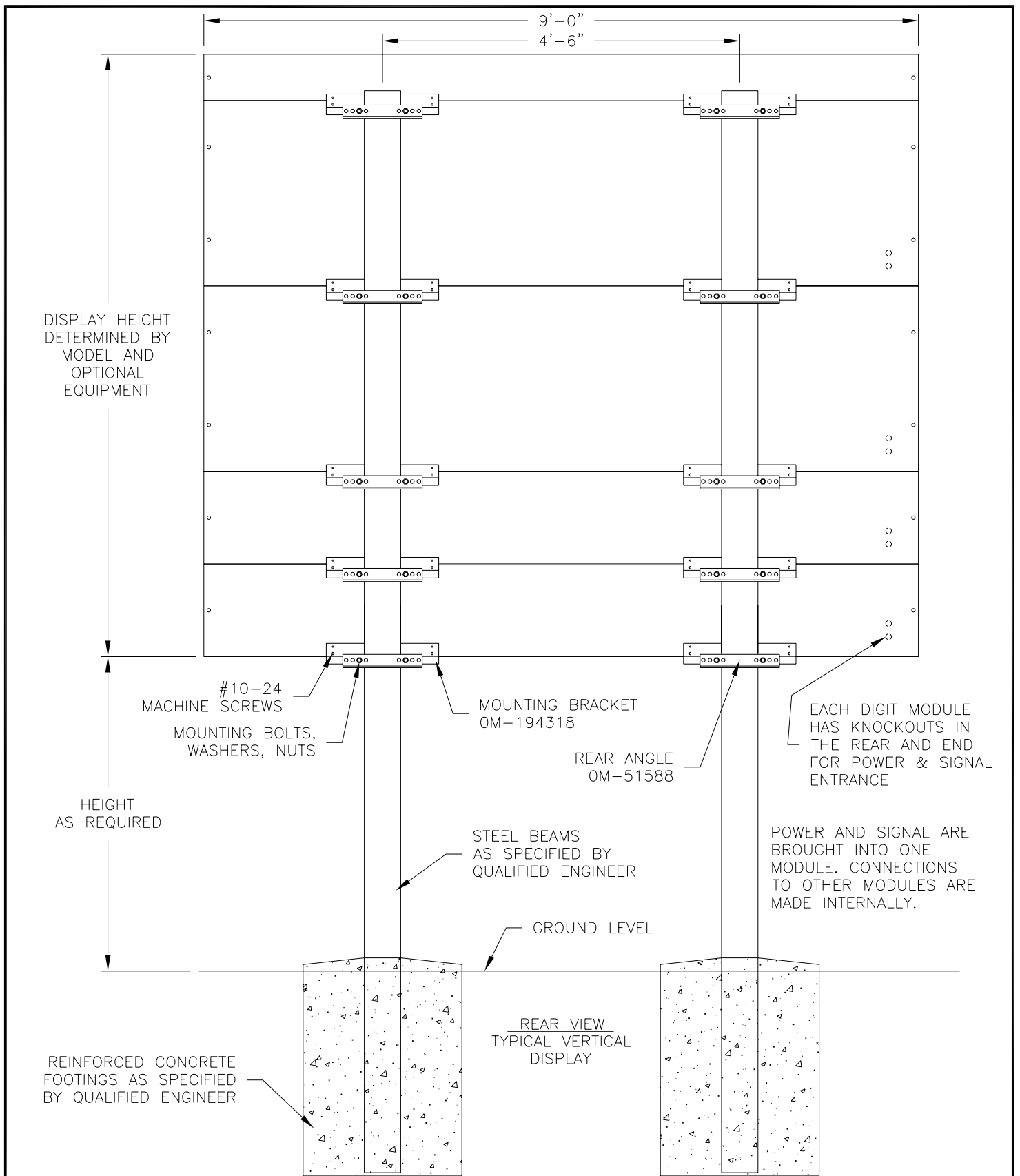

THE CONCEPTS EXPRESSED AND DETAILS SHOWN ON THIS DRAWING ARE CONFIDENTIAL AND PROPRIETARY. DO NOT REPRODUCE BY ANY MEANS, INCLUDING ELECTRONICALLY WITHOUT THE EXPRESSED WRITTEN CONSENT OF DAKTRONICS, INC. COPYRIGHT 2003 DAKTRONICS, INC.

DAKTRONICS, INC. BROOKINGS, SD 57006

PROJ: LED AQUATICS SCOREBOARDS

TITLE: BEAM MOUNTING, REAR VIEW, VERTICAL DISPLAY

DES. BY: A VANBEMMEL

DRAWN BY: M LEOPOLD

DATE: 11 AUG 03

REVISION

APPR. BY:

SCALE: 1=20

1153-R10A-194677

REV.	DATE	DESCRIPTION	BY	APPR.
00				

REV.	DATE	DESCRIPTION	BY	APPR.
------	------	-------------	----	-------

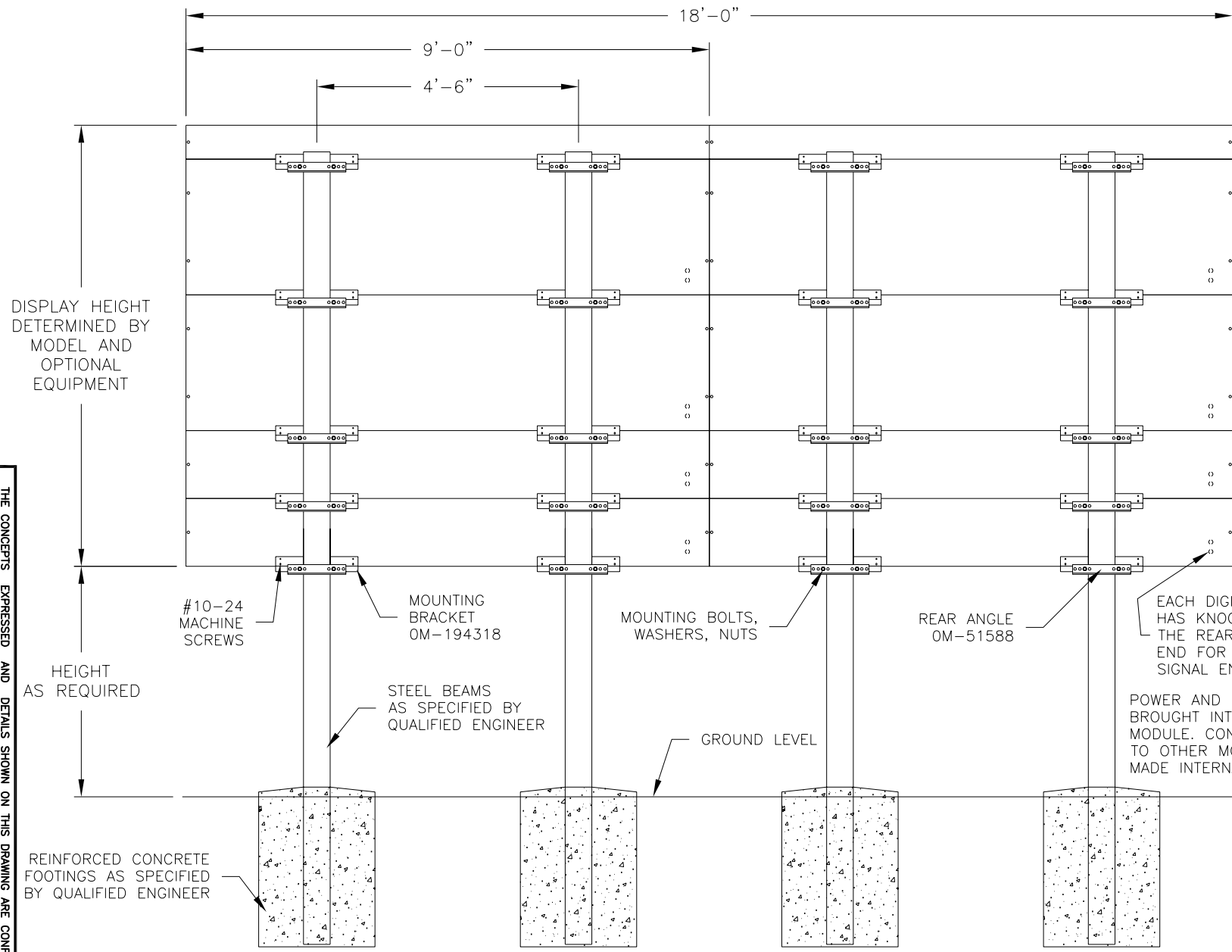

DISPLAY HEIGHT
DETERMINED BY
MODEL AND
OPTIONAL
EQUIPMENT

HEIGHT
AS REQUIRED

REINFORCED CONCRETE
FOOTINGS AS SPECIFIED
BY QUALIFIED ENGINEER

#10-24
MACHINE
SCREWS

MOUNTING
BRACKET
OM-194318

STEEL BEAMS
AS SPECIFIED BY
QUALIFIED ENGINEER

MOUNTING BOLTS,
WASHERS, NUTS

GROUND LEVEL

REAR ANGLE
OM-51588

EACH DIGIT MODULE
HAS KNOCKOUTS IN
THE REAR AND THE
END FOR POWER &
SIGNAL ENTRANCE

POWER AND SIGNAL ARE
BROUGHT INTO ONE
MODULE. CONNECTIONS
TO OTHER MODULES ARE
MADE INTERNALLY.

REAR VIEW
TYPICAL HORIZONTAL
DISPLAY

THE CONCEPTS EXPRESSED AND DETAILS SHOWN ON THIS DRAWING ARE CONFIDENTIAL AND PROPRIETARY. DO NOT REPRODUCE BY ANY MEANS, INCLUDING ELECTRONICALLY WITHOUT THE EXPRESSED WRITTEN CONSENT OF DAKTRONICS, INC. COPYRIGHT 2003 DAKTRONICS, INC.

PROJ: LED AQUATICS SCOREBOARDS
DAKTRONICS, INC. BROOKINGS, SD 57006

TITLE: BEAM MOUNTING, REAR VIEW, HORIZONTAL DISPLAY

DES. BY: A VANBEMMEL DRAWN BY: M LEOPOLD DATE: 11 AUG 03

REVISION 00 APPR. BY: SCALE: 1=30

1153-R10A-194678

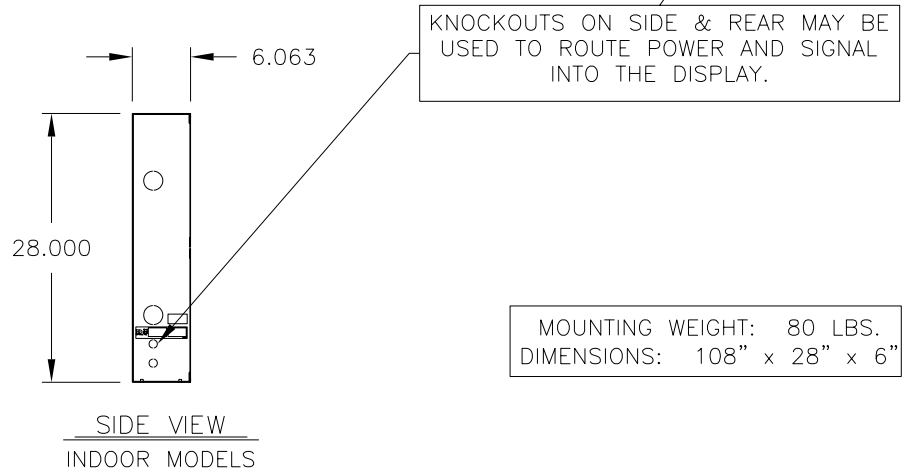
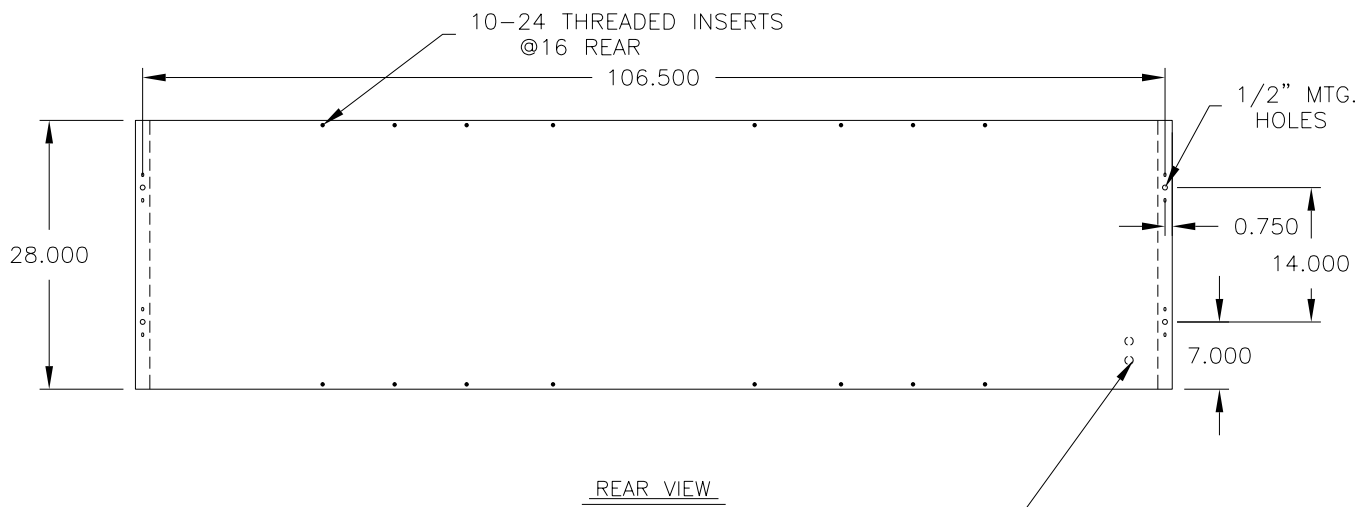
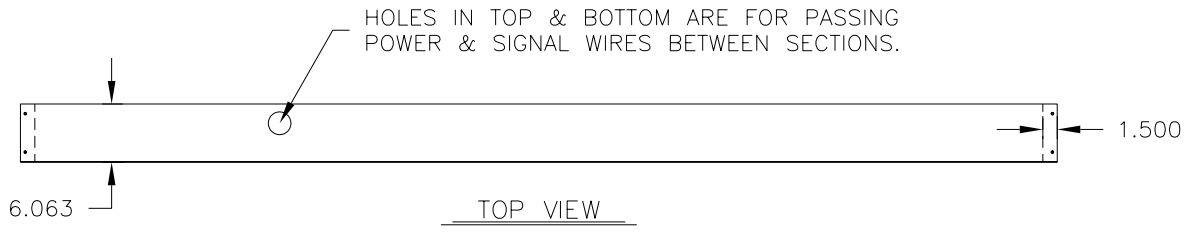

NOTE: -SEE ELECTRICAL SPECIFICATION DRAWINGS FOR THE FRONT VIEWS OF VARIOUS MODELS.

THE CONCEPTS EXPRESSED AND DETAILS SHOWN ON THIS DRAWING ARE CONFIDENTIAL AND PROPRIETARY. DO NOT REPRODUCE BY ANY MEANS, INCLUDING ELECTRONICALLY WITHOUT THE EXPRESSED WRITTEN CONSENT OF DAKTRONICS, INC. COPYRIGHT 2003 DAKTRONICS, INC.			
DAKTRONICS, INC. BROOKINGS, SD 57006			
PROJ: LED AQUATICS SCOREBOARDS			
TITLE: MECHANICAL SPECIFICATIONS, 2-LINE DIGIT MODULE			
DES. BY: A VANBEMMEL		DRAWN BY: M LEOPOLD	
DATE: 11 AUG 03			
REVISION	APPR. BY:	1153-R04A-194679	
01	SCALE: 1=20		

01	25 MAY 05	CORRECTED HEIGHT OF DISPLAY.	AVB	
REV.	DATE	DESCRIPTION	BY	APPR.

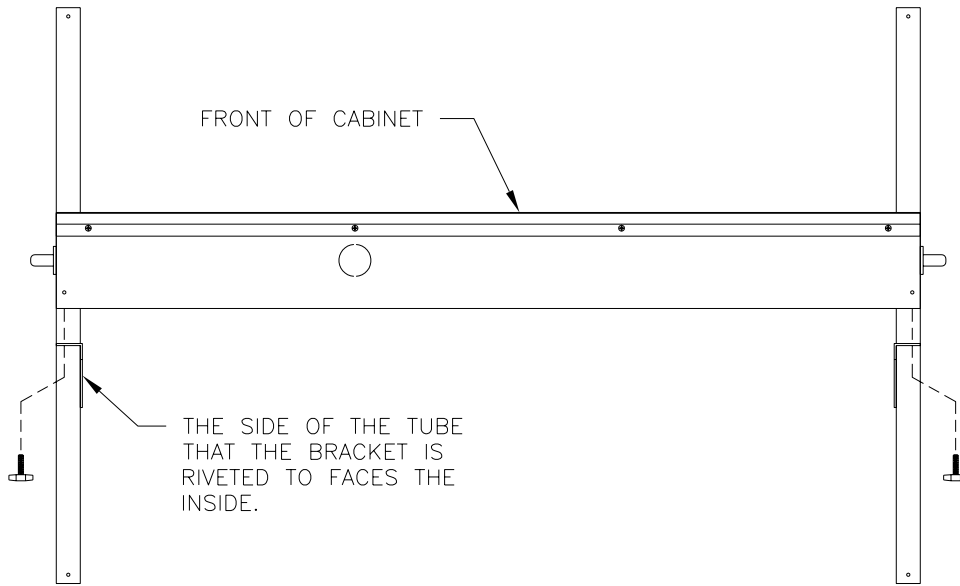

TOP VIEW

NOTES:

THREAD THE 5/16" T-BOLTS THROUGH THE HOLES IN THE BRACKETS AND INTO THE BACK OF THE CABINET. THE SIDE OF THE TUBE THAT THE BRACKET IS RIVETED TO FACES TO THE INSIDE.

REMOVE THE SCREWS FROM THE TOP OF THE CABINET AND USE THEM TO ATTACH THE CAPTION PANEL. THE FLANGE THAT THE SCREWS GO THROUGH FACES THE REAR OF THE CABINET.

#10-24 MACHINE SCREW PROVIDED BY DAKTRONICS

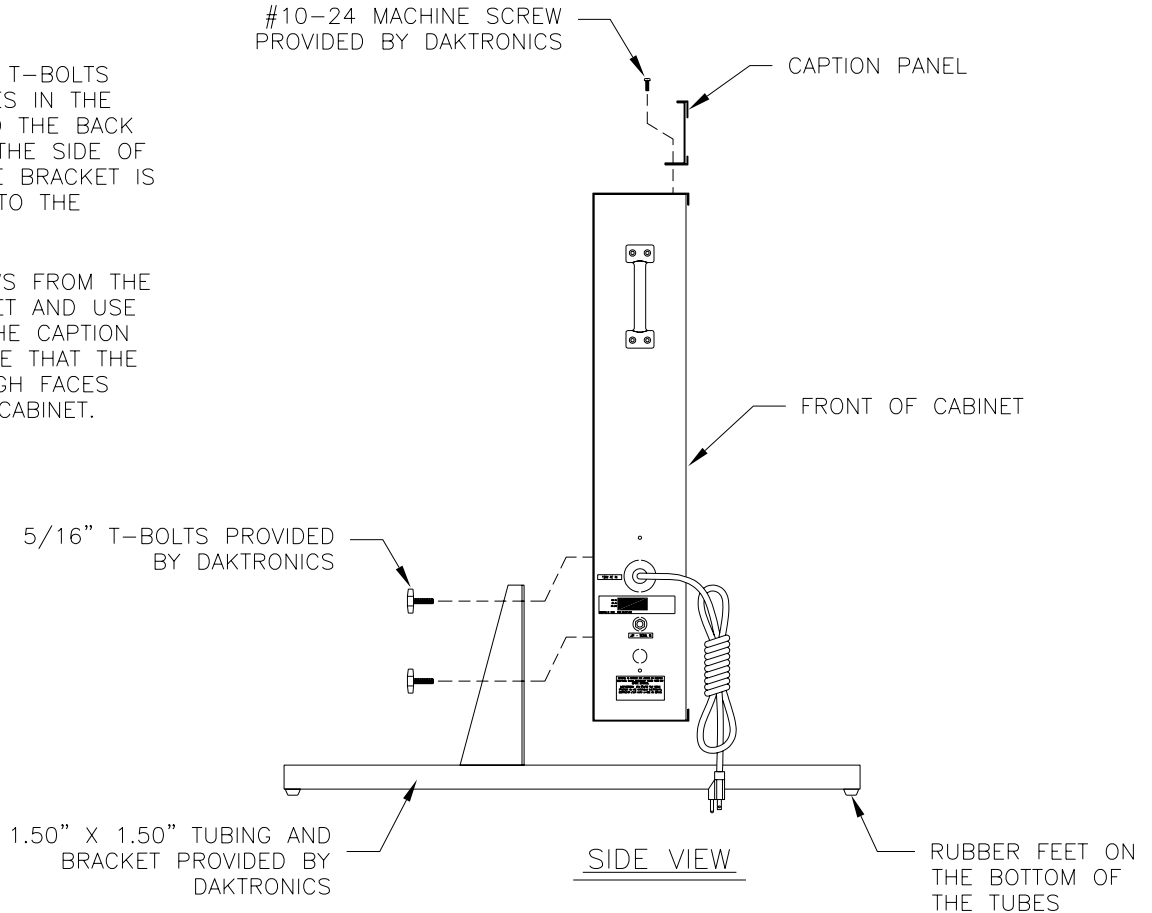

SIDE VIEW

THE CONCEPTS EXPRESSED AND DETAILS SHOWN ON THIS DRAWING ARE CONFIDENTIAL AND PROPRIETARY. DO NOT REPRODUCE BY ANY MEANS, INCLUDING ELECTRONICALLY WITHOUT THE EXPRESSED WRITTEN CONSENT OF DAKTRONICS, INC. COPYRIGHT 2005 DAKTRONICS, INC.			
DAKTRONICS, INC. BROOKINGS, SD 57006			
PROJ:			
TITLE: SW-3104 FLOOR STAND ASSY			
DES. BY:		DRAWN BY: M LEOPOLD	
		DATE: 14 SEP 05	
REVISION	APPR. BY:	1153-R04A-253540	
01	SCALE: 1=12		

01	16 DEC 05	UPDATED CAPTION PANEL AND LOCATION OF HANDLE.	MGL	
REV.	DATE	DESCRIPTION	BY	APPR.

This page intentionally left blank.

B Electrical Drawings

Refer to **Resources (p.2)** for information regarding how to read the drawing number.
Any contract-specific drawings take precedence over these general drawings.

Reference Drawings:

Segmentation, 7 Segment Bar Digit	DWG-38532
Track Scbd w/ Finish Lynx, in Press Box	DWG-104300
Equipment Layout- 50M Swim- Course #1- Indeck	DWG-121329
Electrical Specs, SW-2101-11, -12, -13 & -14.....	DWG-129652
Elec Spec; SW-2001-13, -14, -11 & -12.....	DWG-129984
Electrical Hookup- Outdoor Display	DWG-129998
Elec Spec; SW-2003-13, -14, -11 & -12.....	DWG-130053
Elec Spec; SW-2004-13, -14, -11 & -12.....	DWG-130054
Elec Spec; SW-2006-13, -14, -11 & -12.....	DWG-130284
Elec Spec; SW-2007-13, -14, -11 & -12.....	DWG-130286
Elec Spec; SW-2008-13, -14, -11 & -12.....	DWG-130309
Elec Spec; SW-2002-13, -14, -11 & -12.....	DWG-130312
Elec Spec; SW-2005-13, -14, -11 & -12.....	DWG-130316
Electrical Hookup- Indoor Display- 120 V.....	DWG-130661
Electrical Hookup- Indoor Display- 230 V.....	DWG-130676
Internal Cable Routing.....	DWG-130679
Riser Diagram- with CTS Timer	DWG-130979
Riser Diagram, with Omega Timer	DWG-131037
Elec Spec, SW-2009-13, -14, -11 & -12.....	DWG-131039
System Riser: FB/Track Scbd w/ Omni2K- Track Side.....	DWG-186535
Shop Drawing, SW-3104	DWG-258712
Aquatics- Radio Hookup	DWG-305509
Schematic; 1 Driver, 230VAC	DWG-3033884
Schematic; 1 Driver, 120VAC	DWG-3033885
Schematic; 2 Driver Aquatics Scoreboard	DWG-3033887

This page intentionally left blank.

7 SEGMENT BAR DIGIT
FRONT VIEW

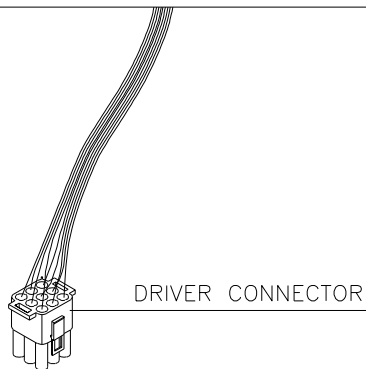
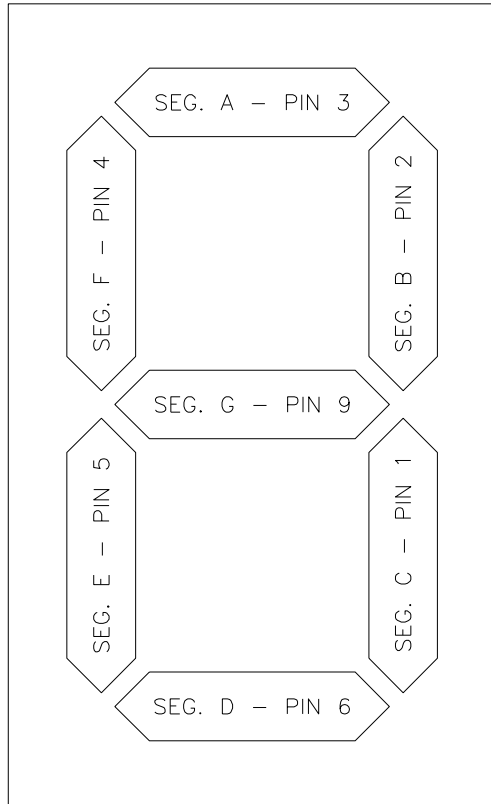

EFFECTIVE APRIL 2021
ALL WIRE COLORS CHANGED
TO BLACK

COLOR CODE		
PIN NO.	WIRE COLOR	DRIVER SEGMENT
1	ORN	C
2	RED	B
3	BRN	A
4	BLU	F
5	PNK	E
6	TAN	D
7	BLK	COM.
8	GRY	H
9	VIO	G

NOTE: "H" SEGMENT, GRAY WIRE IS NOT USED ON 7 SEGMENT BAR DIGIT.

CONNECTOR PIN NUMBERING

NOTE SPLINE NEAR NO. 1

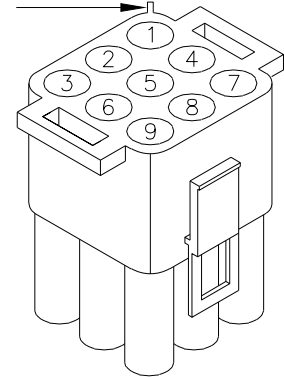

REV 03	DATE: 20 APR 21	CN18578 ADDED NOTE TO CALL OUT CHANGE OF WIRE COLOR TO BLACK EFFECTIVE APRIL 2021.	BY: JSF
		THE CONCEPTS EXPRESSED AND DETAILS SHOWN ON THIS DRAWING ARE CONFIDENTIAL AND PROPRIETARY. DO NOT REPRODUCE BY ANY MEANS WITHOUT THE EXPRESS WRITTEN CONSENT OF DAKTRONICS, INC. OR ITS WHOLLY OWNED SUBSIDIARIES. COPYRIGHT 2021 DAKTRONICS, INC. (USA)	THIRD ANGLE PROJECTION
PROJECT: BASKETBALL			
TITLE: SEGMENTATION- 7 SEGMENT BAR DIGIT			
DATE: 05 JUN 89	DIM UNITS: INCHES [MILLIMETERS]		SHEET
SCALE: 1=4	DO NOT SCALE DRAWING		REV
DESIGN: AVB	JOB NO.	FUNC - TYPE - SIZE	03
DRAWN: HEIDERSCHIEDT P1192	-	- A	38532

2	30 APR 97	ADDED SEGMENT DESIGNATIONS TO DIGIT FIGURE.	AVB	AVB
1	2 JAN 92	CHANGED FROM B-SIZE TO A-SIZE DWG.	C FICK	

TRACK SYSTEM RISER DIAGRAM

TRACK SCBD W/ FINISH LYNX

LYNX SCBD OUTPUT SETTINGS:
 SCRIPT: OMNI1000PLACE.LSS
 BAUD: 9600
 DATA BITS: 7
 PARITY: EVEN
 STOP BITS: 2
 RUNNING TIME: NORMAL
 RESULTS: ON
 PAGE SIZE: EQUAL TO NUMBER OF
 LINES ON SCOREBOARD

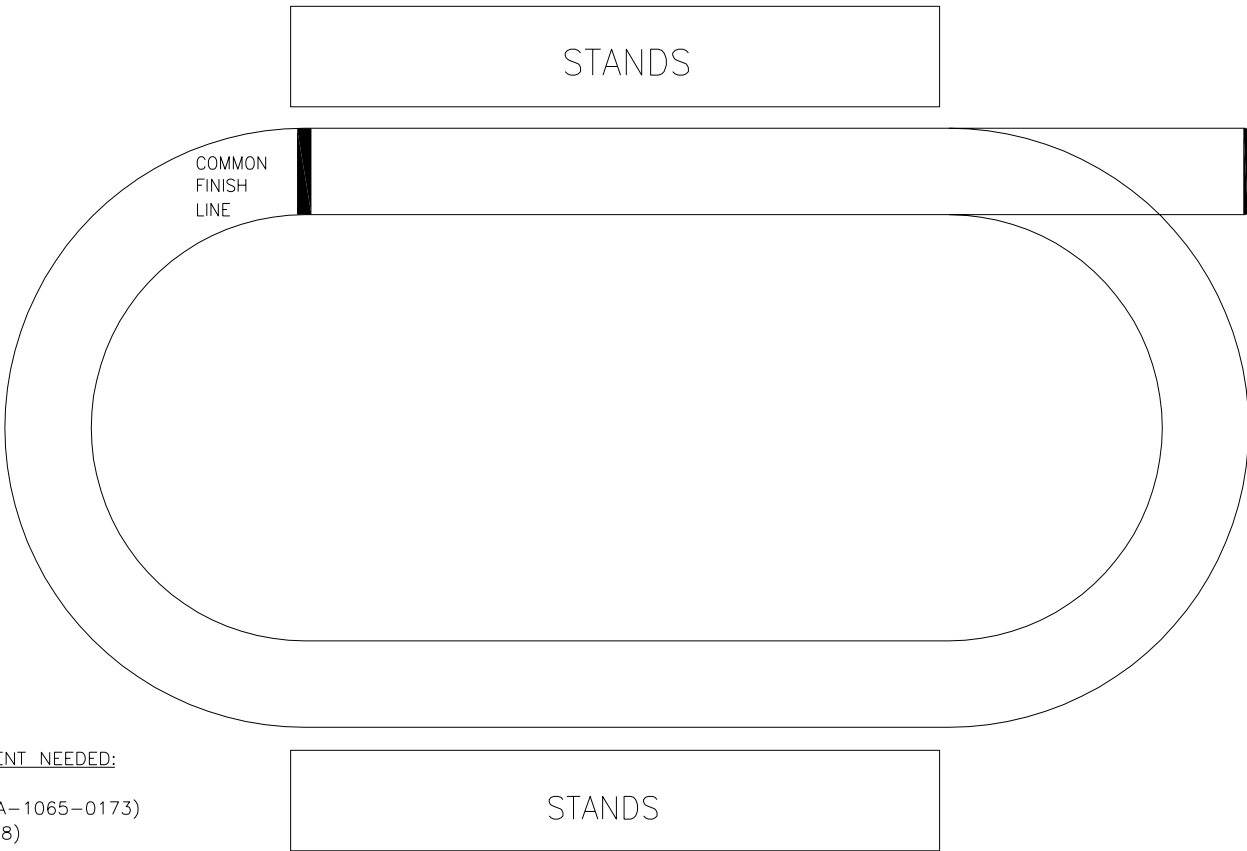
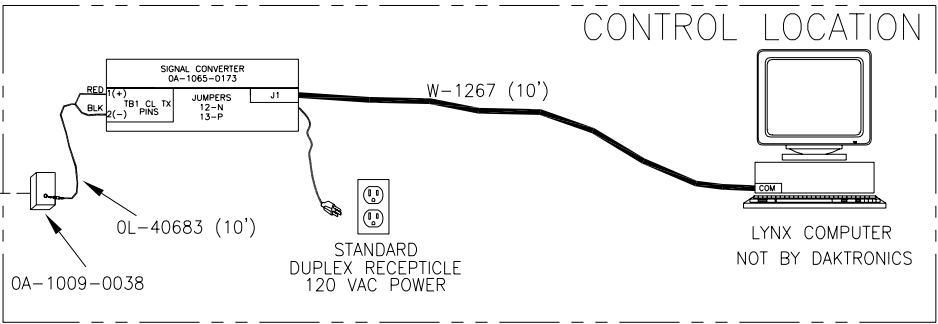

- TYPICAL INTERFACE EQUIPMENT NEEDED:
- | QTY | DESCRIPTION |
|-----|---------------------------------|
| 1 | SIGNAL CONVERTER (OA-1065-0173) |
| 1 | J-BOX (OA-1009-0038) |
| 1 | CABLE (OL-40683) |
| 1 | CABLE (W-1267) |

LANE PLACE TIME
 LED SCOREBOARD

© COPYRIGHT 1997 DAKTRONICS, INC
 DAKTRONICS, INC. BROOKINGS, SD 57006

REV.	DATE	DESCRIPTION	BY	APPR.
05	NOV 07	CHANGED OMNI1000.LSS TO OMNI1000PLACE.LSS	AMG	
04	21 MAR 05	REORGANIZED DRAWING ADDED DETAIL TO SIG CONVERTER	KQB	
3	15 SEP 03	CHANGED SIGNAL CONVERTER DRAWING TO SHOW JACK NUMBERS AND PINS	LWS	
2	28 DEC 98	UPDATED DRAWING, ADDING LYNX SCBD OUTPUT SETTINGS.	CJB	
1	29 JUNE 98	UPDATED DESCRIPTION OF SCBD.	HBB	

PROJ: TRACK SYSTEM RISER DIAGRAM OPTION #4
 TITLE: TRACK SCBD W/ FINISH LYNX, IN PRESS BOX
 DES. BY: HBB
 DRAWN BY: HBONER
 DATE: 26 JUNE 98
 SCALE: 1=1
 1125-R01A-104300

25 YARD/METER 2 COURSE SETUP WITH 2 BULKHEADS

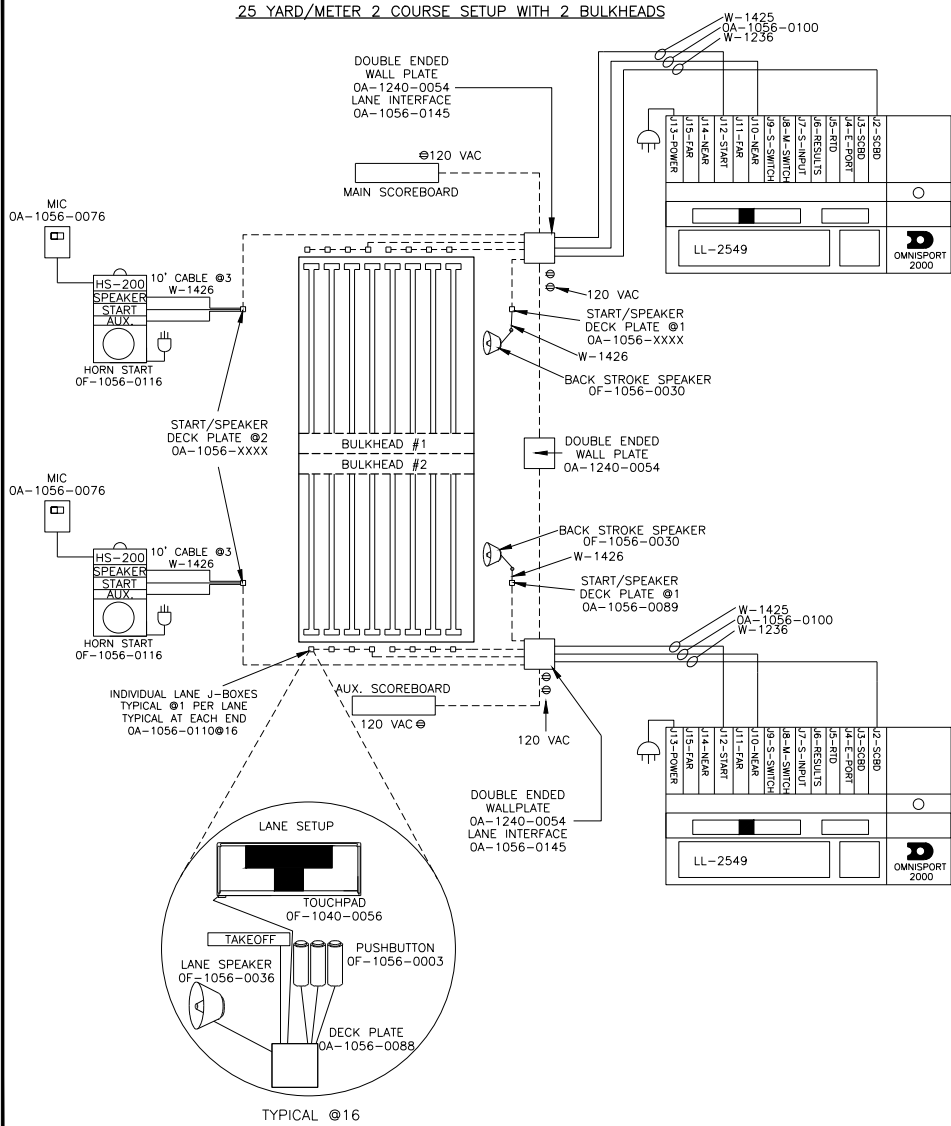

TYPICAL Ø16

50 METER SETUP

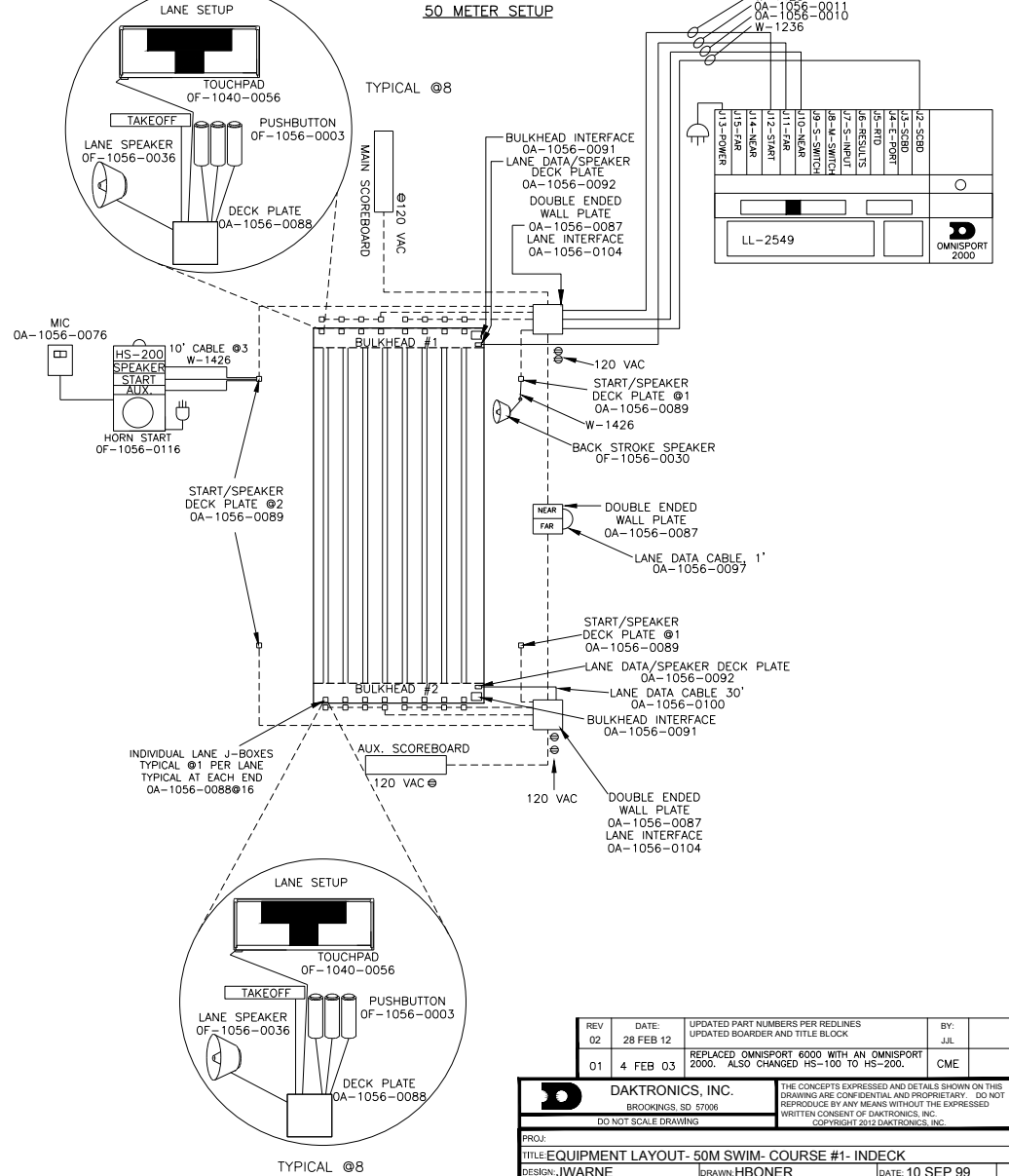

TYPICAL Ø8

REV 02	DATE: 28 FEB 12	UPDATED PART NUMBERS PER REDLINES UPDATED BOARDER AND TITLE BLOCK	BY: JLL
01	4 FEB 03	REPLACED OMNISPORT 6000 WITH AN OMNISPORT 2000. ALSO CHANGED HS-100 TO HS-200.	CME

DAKTRONICS, INC. BROOKINGS, SD 57006		THE CONCEPTS EXPRESSED AND DETAILS SHOWN ON THIS DRAWING ARE CONFIDENTIAL AND PROPRIETARY. DO NOT REPRODUCE BY ANY MEANS WITHOUT THE EXPRESSED WRITTEN CONSENT OF DAKTRONICS, INC. COPYRIGHT 2012 DAKTRONICS, INC.	
DO NOT SCALE DRAWING			
PROJ: TITLE: EQUIPMENT LAYOUT- 50M SWIM- COURSE #1- INDECK			
DESIGN: J.WARNE		DRAWN: H.BONER	DATE: 10 SEP 99
SCALE: NONE			
SHEET	REV 02	JOB NO: P1109	FUNC-TYPE-SIZE: R-10-B
			121329

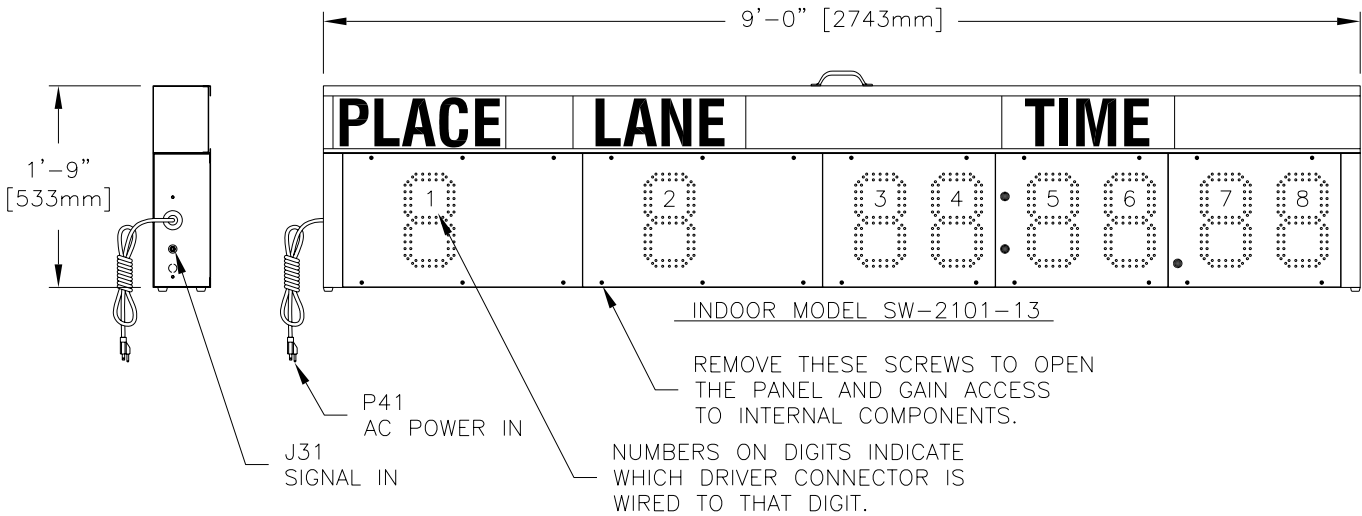

INDOOR MODEL SW-2101-13

REMOVE THESE SCREWS TO OPEN THE PANEL AND GAIN ACCESS TO INTERNAL COMPONENTS.

NUMBERS ON DIGITS INDICATE WHICH DRIVER CONNECTOR IS WIRED TO THAT DIGIT.

MAX POWER DEMAND: 100 W

MODELS SW-2101-11 AND -13 REQUIRE A 120V AC, 15 AMP CIRCUIT AND ARE EQUIPPED WITH A 120V NORTH AMERICAN PLUG.

MODELS SW-2101-12 AND -14 REQUIRE A 230V AC, 10 AMP CIRCUIT AND ARE EQUIPPED WITH AN INTERNATIONAL IEC-320 PLUG.

MODEL NUMBERING:
 SW-2101-13 INDOOR 120V
 SW-2101-14 INDOOR 230V
 SW-2101-11 OUTDOOR 120V
 SW-2101-12 OUTDOOR 230V

CAPTION PANELS ARE CHANGEABLE

MODEL SW-2101-13 SHOWN WITH PANEL AND ENCLOSURE COVER REMOVED

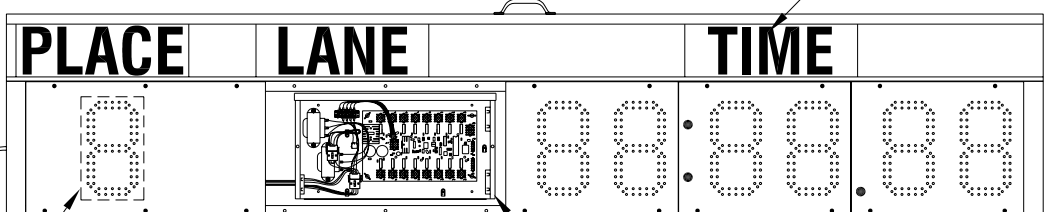

DIGIT CIRCUIT BOARD BEHIND THE PANEL

REV.	DATE	DESCRIPTION	BY	APPR.
04	02 JUN 03	CHANGED DIGIT PATTERN TO G3 CHANGED DRIVER ENCLOSURE	MGL	
03	12 FEB 03	SWITCHED LANE AND PLACE CAPTIONS AROUND.	JJS	
02	4 DEC 02	CHANGED HEIGHT DIMENSION FROM 1'-8" TO 1'-9"	JJS	
01	15 JAN 02	DELETED OUTDOOR DISPLAY, AND PART NUMBER TABLE	ALG	

THE CONCEPTS EXPRESSED AND DETAILS SHOWN ON THIS DRAWING ARE CONFIDENTIAL AND PROPRIETARY. DO NOT REPRODUCE BY ANY MEANS, INCLUDING ELECTRONICALLY WITHOUT THE EXPRESSED WRITTEN CONSENT OF DAKTRONICS, INC. COPYRIGHT 2003 DAKTRONICS, INC.

DAKTRONICS, INC. BROOKINGS, SD 57006

PROJ: LED AQUATICS / TRACK DISPLAYS

TITLE: ELECTRICAL SPECS, SW-2101-11, -12, -13, & -14

DES. BY: AVB DRAWN BY: A VANBEMMEL DATE: 20 MAR 00

REVISION	APPR. BY:	1153-R04A-129652
	SCALE: 1=20	

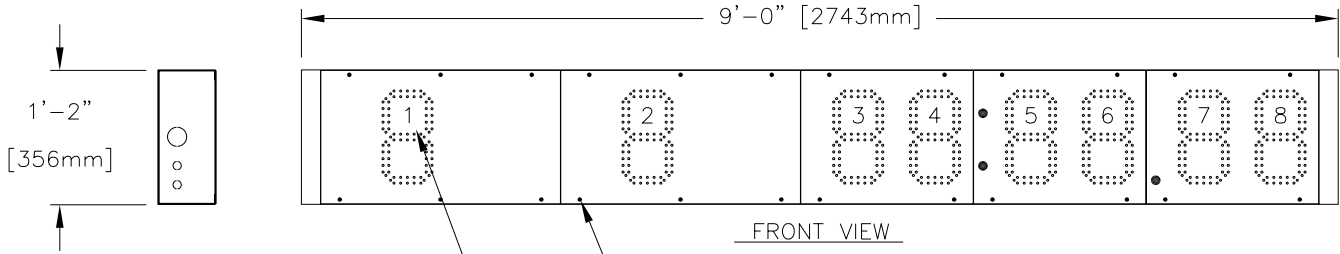

FRONT VIEW

REMOVE THESE SCREWS TO OPEN THE PANEL AND GAIN ACCESS TO INTERNAL COMPONENTS.

NUMBERS ON DIGITS INDICATE WHICH DRIVER CONNECTOR IS WIRED TO THAT DIGIT.

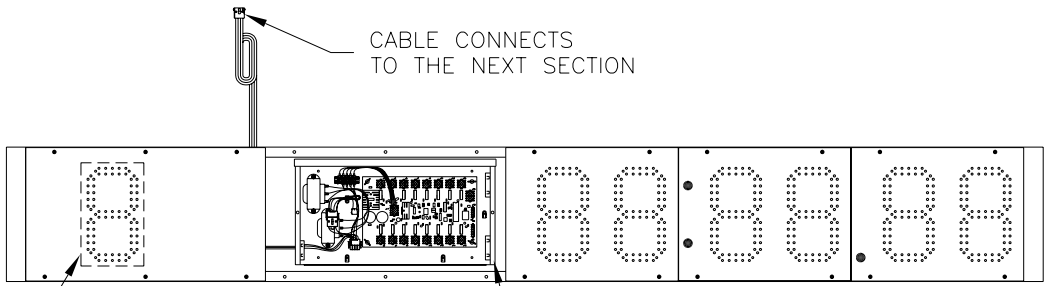

FRONT VIEW

SHOWN WITH PANEL AND ENCLOSURE COVER REMOVED

CABLE CONNECTS TO THE NEXT SECTION

DIGIT CIRCUIT BOARD BEHIND THE PANEL

DRIVER ENCLOSURE

MODEL:
 SW-2001-13 120V AC, INDOOR
 SW-2001-14 230V AC, INDOOR
 SW-2001-11 120V AC, OUTDOOR
 SW-2001-12 230V AC, OUTDOOR

MAX POWER DEMAND: 200 W

THE CONCEPTS EXPRESSED AND DETAILS SHOWN ON THIS DRAWING ARE CONFIDENTIAL AND PROPRIETARY. DO NOT REPRODUCE BY ANY MEANS, INCLUDING ELECTRONICALLY WITHOUT THE EXPRESSED WRITTEN CONSENT OF DAKTRONICS, INC. COPYRIGHT 2003 DAKTRONICS, INC.

DAKTRONICS, INC. BROOKINGS, SD 57006

PROJ: LED AQUATICS / TRACK DISPLAYS

TITLE: ELEC SPEC; SW-2001-13, -14, -11, & -12

DES. BY: AVB DRAWN BY: DWEIBEL DATE: 23 MAR 00

REVISION APPR. BY: 1153-R04A-129984

SCALE: 1=20

REV.	DATE	DESCRIPTION	BY	APPR.
02	02 JUN 03	CHANGED DIGIT PATTERN TO G3 CHANGED DRIVER ENCLOSURE	MGL	
01	15 JAN 02	DELETED OUTDOOR DISPLAY, AND PART NUMBER TABLE.	ALG	

PROCEDURE

1. MOUNT THE LOAD CENTER IN THE LOWEST MODULE IN THE DISPLAY. REMOVE THE NUTS FROM THREE SCREWS IN THE MODULE, POSITION THE LOAD CENTER ON THE SCREWS, AND SECURE WITH THE NUTS TO MOUNT.
2. ROUTE THE CABLE FROM THE LOAD CENTER INTO THE DRIVER ENCLOSURE AND CONNECT THE J51 JACK TO THE MATING P51 PLUG.
3. INSERT 2" BUSHINGS INTO THE HOLES BETWEEN MODULES.
4. PULL THE POWER/SIGNAL CABLE FROM THE LOWER MODULE UP INTO THE NEXT MODULE AND CONNECT THE J51 JACK TO THE MATING P51 PLUG.
5. REPEAT THIS CONNECTION FOR THE OTHER MODULES.
6. MAKE MAIN POWER AND SIGNAL CONNECTIONS IN THE LOAD CENTER.
7. REPLACE COVERS AND PANELS.

2-LINE MODULE (SHOWN WITH THE LOWER LEFT PANELS REMOVED)

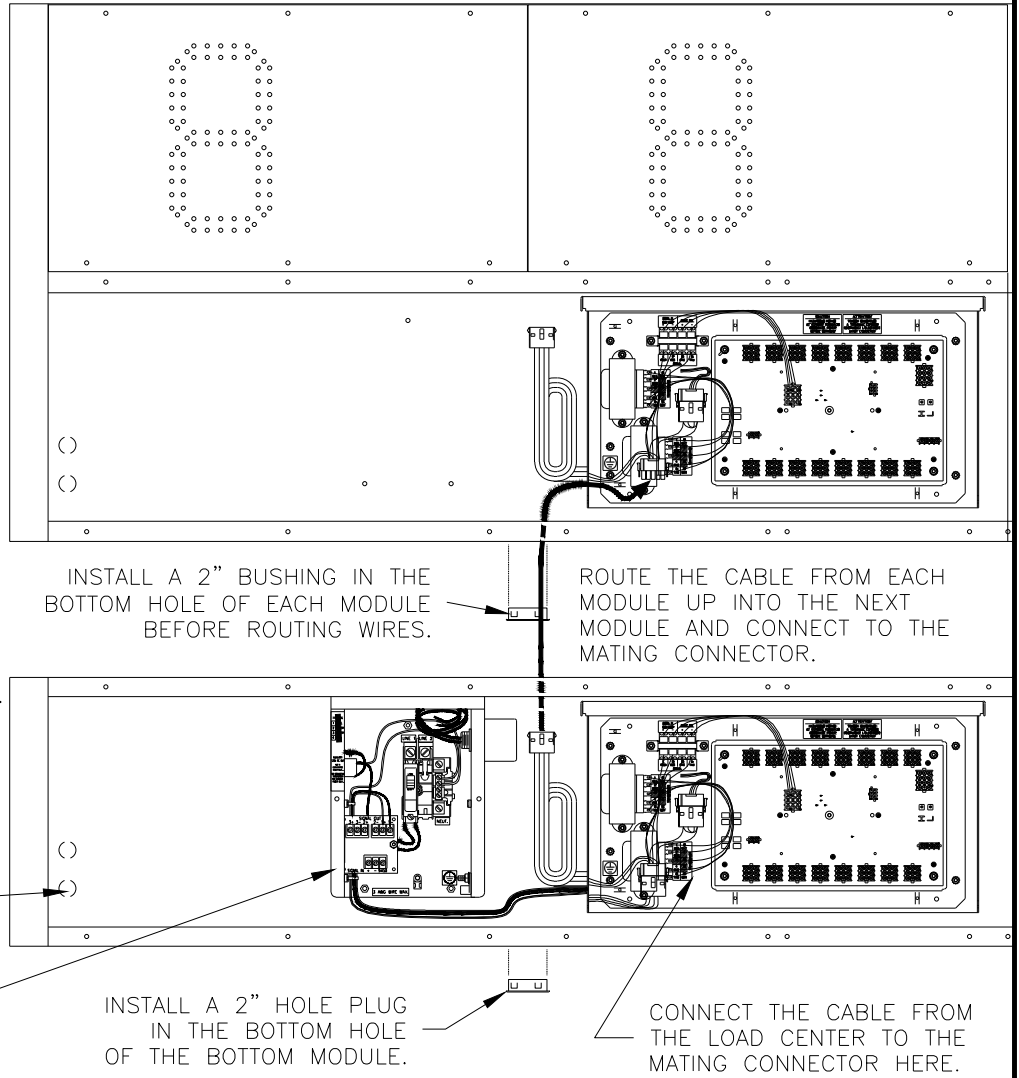

KNOCKOUTS IN THE END AND BACK MAY BE USED TO ROUTE POWER AND SIGNAL INTO DISPLAY

LOAD CENTER INSTALL COVER WHEN HOOKUP IS COMPLETE

INSTALL A 2" BUSHING IN THE BOTTOM HOLE OF EACH MODULE BEFORE ROUTING WIRES.

ROUTE THE CABLE FROM EACH MODULE UP INTO THE NEXT MODULE AND CONNECT TO THE MATING CONNECTOR.

INSTALL A 2" HOLE PLUG IN THE BOTTOM HOLE OF THE BOTTOM MODULE.

CONNECT THE CABLE FROM THE LOAD CENTER TO THE MATING CONNECTOR HERE.

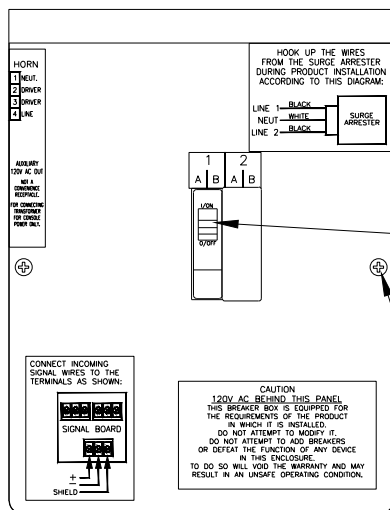

LOAD CENTER WITH COVER ON

LOAD CENTER PART NUMBER 0A-1153-0177

120V AC LINE (HOT)

SURGE ARRESTER CONNECT WIRES TO POWER TERMINALS

15 AMP CIRCUIT BREAKER

REMOVE THESE TWO SCREWS TO GAIN ACCESS TO HOOKUP TERMINALS

CONNECT SIGNAL WIRE HERE

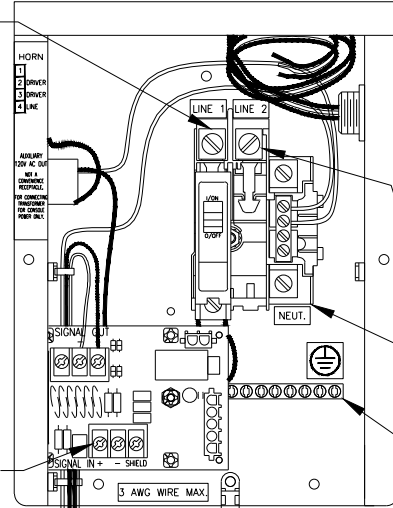

LOAD CENTER WITH COVER REMOVED

DAKTRONICS, INC. BROOKINGS, SD 57006 DO NOT SCALE DRAWING		THE CONCEPTS EXPRESSED AND DETAILS SHOWN ON THIS DRAWING ARE CONFIDENTIAL AND PROPRIETARY. DO NOT REPRODUCE BY ANY MEANS WITHOUT THE EXPRESS WRITTEN CONSENT OF DAKTRONICS, INC. COPYRIGHT 2015 DAKTRONICS, INC.				
		PROJ: LED AQUATICS SCOREBOARD TITLE: ELECTRICAL HOOKUP- OUTDOOR DISPLAY				
03	10 APR 15	UPDATED DIGIT DRIVER SWAPPED 12-PIN PLUG WITH 5-PIN	BJG	DESIGN: AVB	DRAWN: A VANBEMMEL	DATE: 24 MAR 00
02	02 JUN 03	CHANGED DIGIT PATTERN TO G3 CHANGED DRIVER ENCLOSURE	MGL	SCALE: 1=10		
01	15 JAN 02	CHANGED PUNCH PATTERN	ALG	SHEET	REV 03	JOB NO: P1153
				FUNC-TYPE-SIZE	R-10-A	
						129998

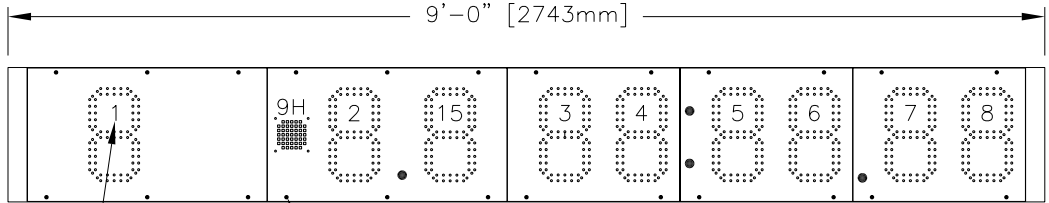
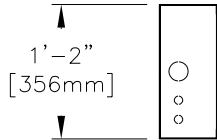

FRONT VIEW

NUMBERS ON DIGITS INDICATE WHICH DRIVER CONNECTOR IS WIRED TO THAT DIGIT.

REMOVE THESE SCREWS TO OPEN THE PANEL AND GAIN ACCESS TO INTERNAL COMPONENTS.

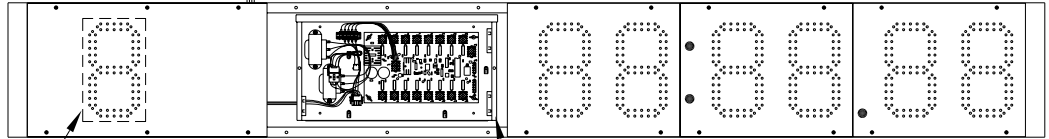

FRONT VIEW

SHOWN WITH PANEL AND ENCLOSURE COVER REMOVED

DIGIT CIRCUIT BOARD BEHIND THE PANEL

DRIVER ENCLOSURE

MODEL:

- SW-2003-13 120V AC, INDOOR
- SW-2003-14 230V AC, INDOOR
- SW-2003-11 120V AC, OUTDOOR
- SW-2003-12 230V AC, OUTDOOR

MAX POWER DEMAND: 200 W

THE CONCEPTS EXPRESSED AND DETAILS SHOWN ON THIS DRAWING ARE CONFIDENTIAL AND PROPRIETARY. DO NOT REPRODUCE BY ANY MEANS, INCLUDING ELECTRONICALLY WITHOUT THE EXPRESSED WRITTEN CONSENT OF DAKTRONICS, INC. COPYRIGHT 2003 DAKTRONICS, INC.

DAKTRONICS, INC. BROOKINGS, SD 57006

PROJ: LED AQUATICS / TRACK DISPLAYS

TITLE: ELEC SPEC; SW-2003-13, -14, -11, & -12

DES. BY: AVB DRAWN BY: DWEIBEL DATE: 25 MAR 00

REVISION APPR. BY: SCALE: 1=20 1153-R04A-130053

REV.	DATE	DESCRIPTION	BY	APPR.
02	02 JUN 03	CHANGED DIGIT PATTERN TO G3 CHANGED DRIVER ENCLOSURE	MGL	
01	15 JAN 02	DELETED OUTDOOR DISPLAY, AND PART NUMBER TABLE.	ALG	

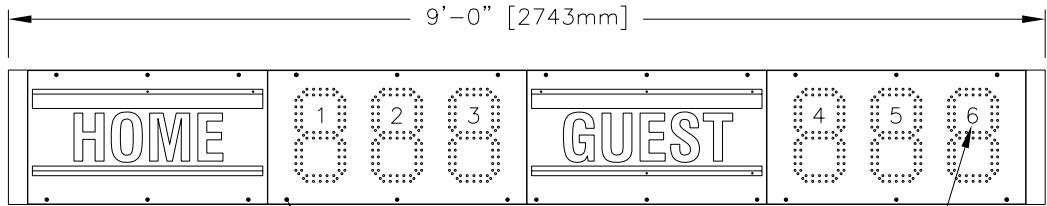
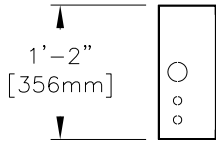

FRONT VIEW

REMOVE THESE SCREWS TO OPEN THE PANEL AND GAIN ACCESS TO INTERNAL COMPONENTS.

NUMBERS ON DIGITS INDICATE WHICH DRIVER CONNECTOR IS WIRED TO THAT DIGIT.

CABLE CONNECTS TO THE NEXT SECTION

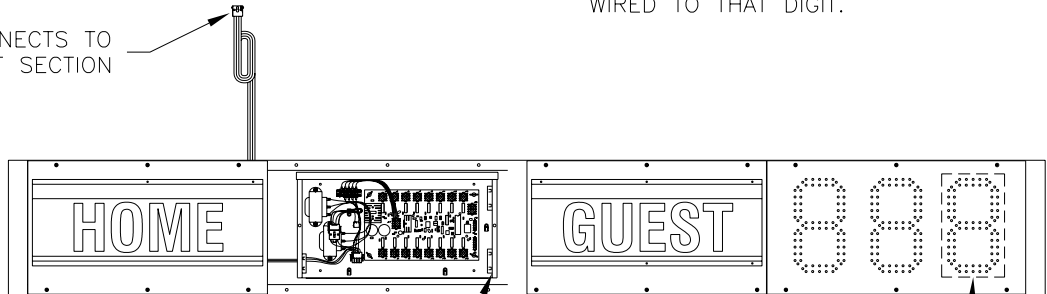

FRONT VIEW

SHOWN WITH PANEL AND ENCLOSURE COVER REMOVED

DIGIT CIRCUIT BOARD BEHIND PANEL

DRIVER ENCLOSURE

MODEL:

- SW-2004-13 120V AC, INDOOR
- SW-2004-14 230V AC, INDOOR
- SW-2004-11 120V AC, OUTDOOR
- SW-2004-12 230V AC, OUTDOOR

MAX POWER DEMAND: 200 W

THE CONCEPTS EXPRESSED AND DETAILS SHOWN ON THIS DRAWING ARE CONFIDENTIAL AND PROPRIETARY. DO NOT REPRODUCE BY ANY MEANS, INCLUDING ELECTRONICALLY WITHOUT THE EXPRESSED WRITTEN CONSENT OF DAKTRONICS, INC. COPYRIGHT 2003 DAKTRONICS, INC.

DAKTRONICS, INC. BROOKINGS, SD 57006

PROJ: LED AQUATICS / TRACK DISPLAYS

TITLE: ELEC SPEC; SW-2004-13, -14, -11, & -12

DES. BY: AVB

DRAWN BY: DWEIBEL

DATE: 25 MAR 00

REVISION

APPR. BY:

SCALE: 1=20

1153-R04A-130054

REV.	DATE	DESCRIPTION	BY	APPR.
02	02 JUN 03	CHANGED DIGIT PATTERN TO G3 CHANGED DRIVER ENCLOSURE	MGL	
01	15 JAN 02	DELETED OUTDOOR DISPLAY, AND PART NUMBER TABLE.	ALG	

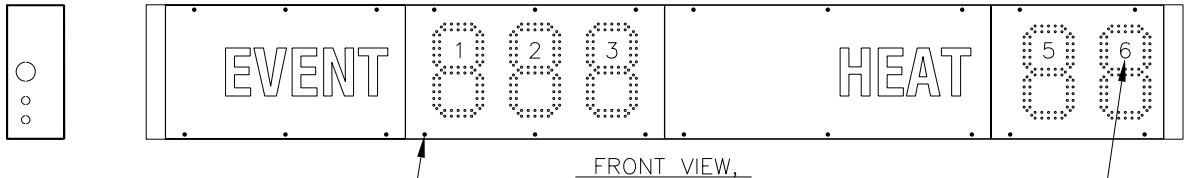

FRONT VIEW,

REMOVE THESE SCREWS TO OPEN THE PANEL AND GAIN ACCESS TO INTERNAL COMPONENTS

NUMBERS ON DIGITS INDICATE WHICH DRIVER CONNECTOR IS WIRED TO THAT DIGIT.

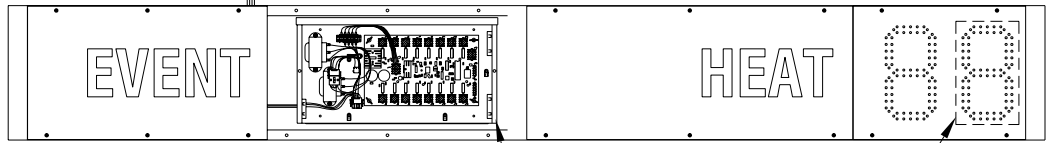
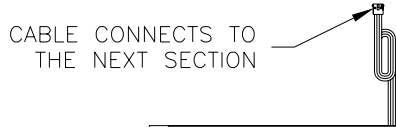

FRONT VIEW

SHOWN WITH PANEL AND ENCLOSURE COVER REMOVED

DRIVER ENCLOSURE

DIGIT CIRCUIT BOARD BEHIND THE PANEL

MODEL:

- SW-2006-13 120V AC, INDOOR
- SW-2006-14 230V AC, INDOOR
- SW-2006-11 120V AC, OUTDOOR
- SW-2006-12 230V AC, OUTDOOR

MAX POWER DEMAND: 200 W

THE CONCEPTS EXPRESSED AND DETAILS SHOWN ON THIS DRAWING ARE CONFIDENTIAL AND PROPRIETARY. DO NOT REPRODUCE BY ANY MEANS, INCLUDING ELECTRONICALLY WITHOUT THE EXPRESSED WRITTEN CONSENT OF DAKTRONICS, INC. COPYRIGHT 2003 DAKTRONICS, INC.

DAKTRONICS, INC. BROOKINGS, SD 57006

PROJ: LED AQUATICS / TRACK DISPLAYS

TITLE: ELEC SPEC; SW-2006-13, -14, -11, & -12

DES. BY: AVB

DRAWN BY: DWEIBEL

DATE: 30 MAR 00

REVISION

APPR. BY:

SCALE: 1=20

1153-R04A-130284

REV.	DATE	DESCRIPTION	BY	APPR.
02	02 JUN 03	CHANGED DIGIT PATTERN TO G3 CHANGED DRIVER ENCLOSURE	MGL	
01	15 JAN 02	DELETED OUTDOOR DISPLAY, AN PART NUMBER TABLE.	ALG	

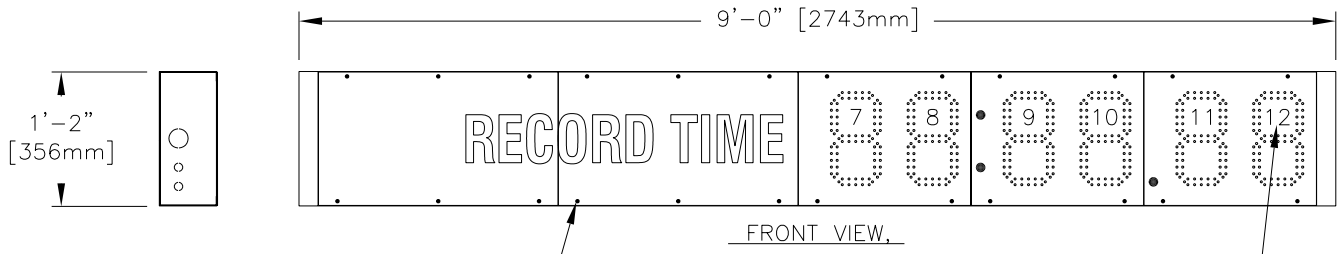

REMOVE THESE SCREWS TO OPEN THE PANEL AND GAIN ACCESS TO INTERNAL COMPONENTS.

NUMBERS ON DIGITS INDICATE WHICH DRIVER CONNECTOR IS WIRED TO THAT DIGIT

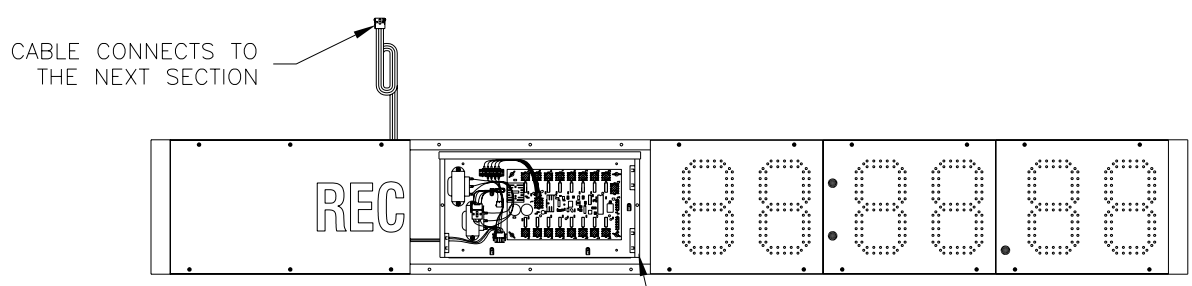

SHOWN WITH PANEL AND ENCLOSURE COVER REMOVED

DRIVER ENCLOSURE

MODEL:
 SW-2007-13 120V AC, INDOOR
 SW-2007-14 230V AC, INDOOR
 SW-2007-11 120V AC, OUTDOOR
 SW-2007-12 230V AC, OUTDOOR

MAX POWER DEMAND: 200 W

THE CONCEPTS EXPRESSED AND DETAILS SHOWN ON THIS DRAWING ARE CONFIDENTIAL AND PROPRIETARY. DO NOT REPRODUCE BY ANY MEANS, INCLUDING ELECTRONICALLY WITHOUT THE EXPRESSED WRITTEN CONSENT OF DAKTRONICS, INC. COPYRIGHT 2003 DAKTRONICS, INC.

DAKTRONICS, INC. BROOKINGS, SD 57006

PROJ: LED AQUATICS / TRACK DISPLAYS

TITLE: ELEC SPEC; SW-2007-13, -14, -11, &-12

DES. BY: AVB DRAWN BY: DWEIBEL DATE: 30 MAR 00

REVISION APPR. BY: SCALE: 1=20 1153-R04A-130286

REV.	DATE	DESCRIPTION	BY	APPR.
02	02 JUN 03	CHANGED DIGIT PATTERN TO G3 CHANGED DRIVER ENCLOSURE	MGL	
01	15 JAN 02	DELETED OUTDOOR DISPLAY, AND PART NUMBER TABLE.	ALG	

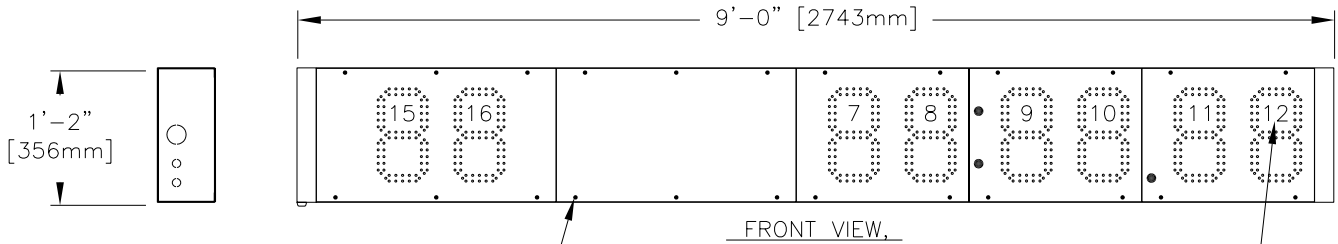

REMOVE THESE SCREWS TO OPEN THE PANEL AND GAIN ACCESS TO INTERNAL COMPONENTS.

NUMBERS ON DIGITS INDICATE WHICH DRIVER CONNECTOR IS WIRED TO THAT DIGIT

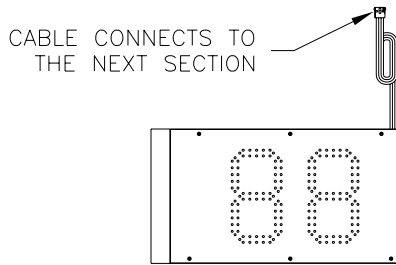

CABLE CONNECTS TO THE NEXT SECTION

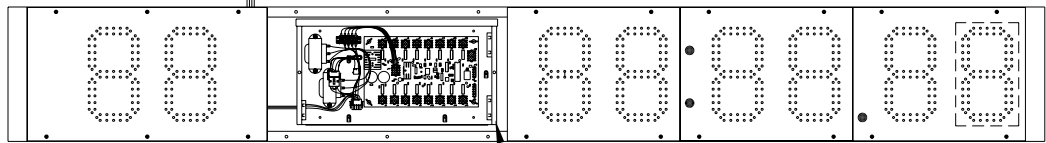

FRONT VIEW
SHOWN WITH PANEL AND ENCLOSURE COVER REMOVED

DRIVER ENCLOSURE

MODEL:

- SW-2008-13 120V AC, INDOOR
- SW-2008-14 230V AC, INDOOR
- SW-2008-11 120V AC, OUTDOOR
- SW-2008-12 230V AC, OUTDOOR

MAX POWER DEMAND: 200 W

THE CONCEPTS EXPRESSED AND DETAILS SHOWN ON THIS DRAWING ARE CONFIDENTIAL AND PROPRIETARY. DO NOT REPRODUCE BY ANY MEANS, INCLUDING ELECTRONICALLY WITHOUT THE EXPRESSED WRITTEN CONSENT OF DAKTRONICS, INC. COPYRIGHT 2003 DAKTRONICS, INC.

DAKTRONICS, INC. BROOKINGS, SD 57006

PROJ: LED AQUATICS / TRACK DISPLAYS

TITLE: ELEC SPEC; SW-2008-13, -14, -11, & -12

DES. BY: AVB DRAWN BY: DWEIBEL DATE: 31 MAR 00

REVISION APPR. BY: 1153-R04A-130309
SCALE: 1=20

REV.	DATE	DESCRIPTION	BY	APPR.
02	02 JUN 03	CHANGED DIGIT PATTERN TO G3 CHANGED DRIVER ENCLOSURE	MGL	
01	15 JAN 02	DELETED OUTDOOR DISPLAY, AND PART NUMBER TABLE.	ALG	

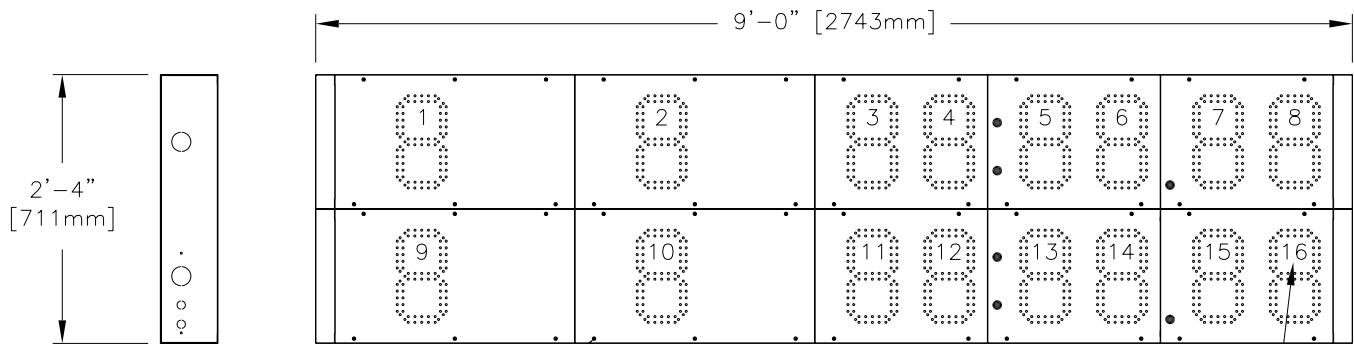

FRONT VIEW

REMOVE THESE SCREWS TO OPEN THE PANEL AND GAIN ACCESS TO INTERNAL COMPONENTS

NUMBERS ON DIGITS INDICATE WHICH DRIVER CONNECTOR IS WIRED TO THAT DIGIT

CABLE CONNECTS TO THE NEXT SECTION

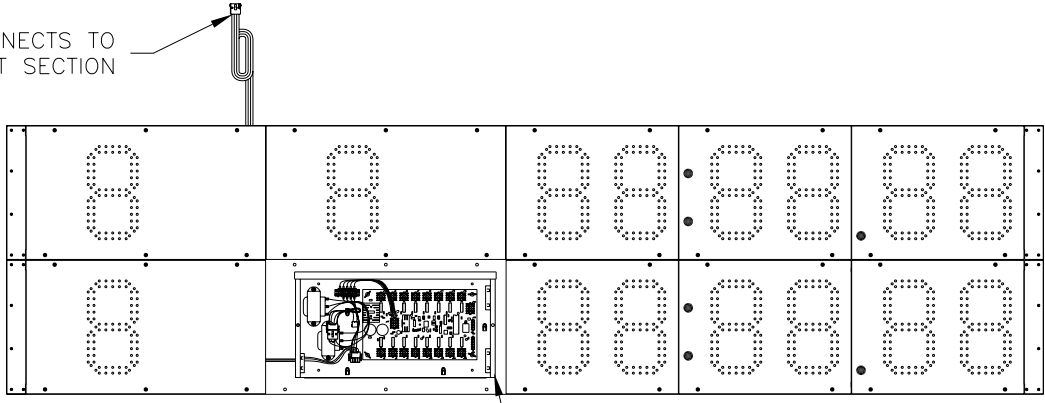

FRONT VIEW

SHOWN WITH PANEL AND ENCLOSURE COVER REMOVED

DRIVER ENCLOSURE

MODEL:
 SW-2002-13 120V AC, INDOOR
 SW-2002-14 230V AC, INDOOR
 SW-2002-11 120V AC, OUTDOOR
 SW-2002-12 230V AC, OUTDOOR

MAX POWER DEMAND: 200 W

THE CONCEPTS EXPRESSED AND DETAILS SHOWN ON THIS DRAWING ARE CONFIDENTIAL AND PROPRIETARY. DO NOT REPRODUCE BY ANY MEANS, INCLUDING ELECTRONICALLY WITHOUT THE EXPRESSED WRITTEN CONSENT OF DAKTRONICS, INC. COPYRIGHT 2003 DAKTRONICS, INC.

DAKTRONICS, INC. BROOKINGS, SD 57006

PROJ: LED AQUATICS / TRACK DISPLAYS

TITLE: ELEC SPEC; SW-2002-13, -14, -11, & -12

DES. BY: AVB DRAWN BY: DWEIBEL DATE: 31 MAR 00

REVISION APPR. BY: 1153-R04A-130312

REV.	DATE	DESCRIPTION	BY	APPR.
02	02 JUN 03	CHANGED DIGIT PATTERN TO G3 CHANGED DRIVER ENCLOSURE	MGL	
01	15 JAN 02	DELETED OUTDOOR DISPLAY, AND PART NUMBER TABLE	ALG	

SCALE: 1=20

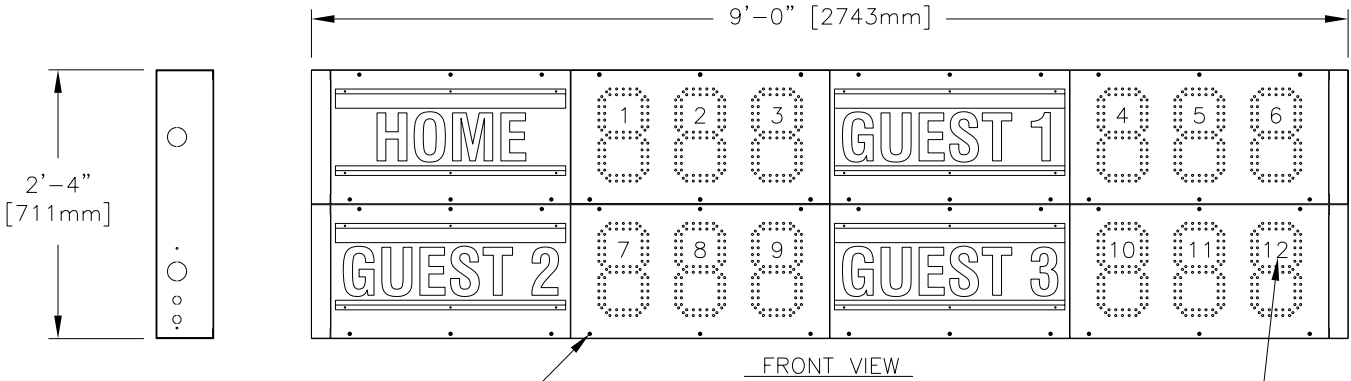

REMOVE THESE SCREWS TO OPEN THE PANEL AND GAIN ACCESS TO INTERNAL COMPONENTS

NUMBERS ON DIGITS INDICATE WHICH DRIVER CONNECTOR IS WIRED TO THAT DIGIT

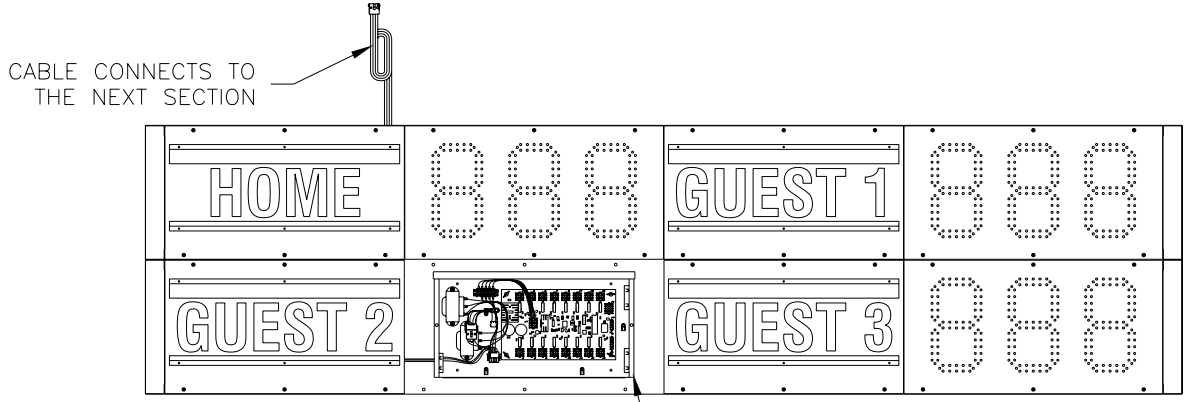

FRONT VIEW
SHOWN WITH PANEL AND ENCLOSURE COVER REMOVED

DRIVER ENCLOSURE

MODEL:
 SW-2005-13 120V AC, INDOOR
 SW-2005-14 230V AC, INDOOR
 SW-2005-11 120V AC, OUTDOOR
 SW-2005-12 230V AC, OUTDOOR

MAX POWER DEMAND: 200 W

THE CONCEPTS EXPRESSED AND DETAILS SHOWN ON THIS DRAWING ARE CONFIDENTIAL AND PROPRIETARY. DO NOT REPRODUCE BY ANY MEANS, INCLUDING ELECTRONICALLY WITHOUT THE EXPRESSED WRITTEN CONSENT OF DAKTRONICS, INC. COPYRIGHT 2003 DAKTRONICS, INC.

DAKTRONICS, INC. BROOKINGS, SD 57006

PROJ: LED AQUATICS / TRACK DISPLAYS
 TITLE: ELEC SPEC; SW-2005-13, -14, -11, & -12
 DES. BY: AVB DRAWN BY: DWEIBEL DATE: 31 MAR 00

REV.	DATE	DESCRIPTION	BY	APPR.
02	02 JUN 03	CHANGED DIGIT PATTERN TO G3 CHANGED DRIVER ENCLOSURE	MGL	
01	15 JAN 02	DELETED OUTDOOR DISPLAY, AND PART NUMBER TABLE.	ALG	

REVISION APPR. BY: 1153-R04A-130316
 SCALE: 1=20

2-LINE MODULE (SHOWN WITH THE LOWER LEFT PANELS REMOVED)

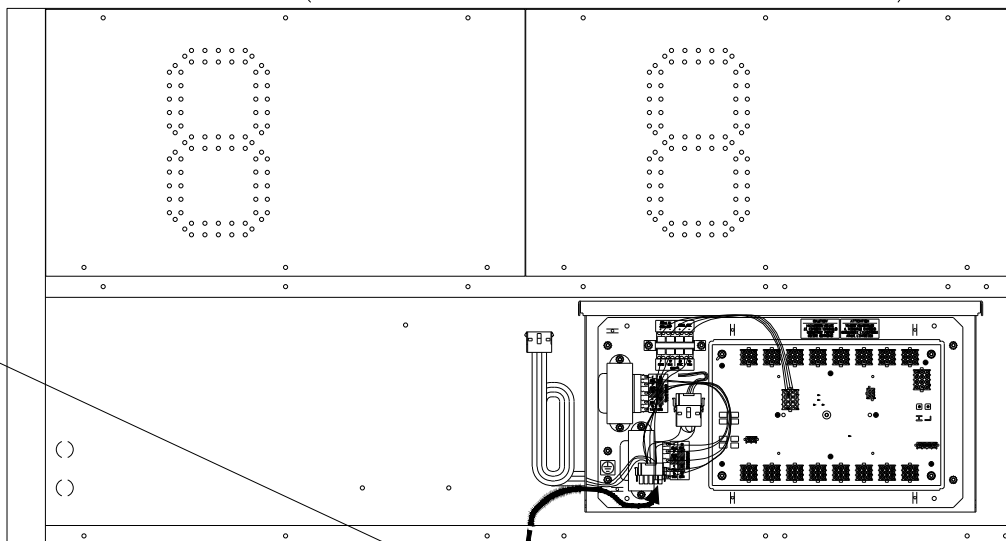

INSTALL A 2" BUSHING IN THE BOTTOM HOLE OF EACH MODULE BEFORE ROUTING WIRES. (IF NOT ALREADY INSTALLED)

REMOVE THE 2" AND UPPER 7/8" KNOCKOUTS FROM THE LEFT SIDE OF THE MODULE.

ROUTE THE CABLE FROM EACH MODULE UP INTO THE NEXT MODULE AND CONNECT TO THE MATING CONNECTOR.

1-LINE MODULE (SHOWN WITH THE LEFT FRONT PANELS REMOVED)

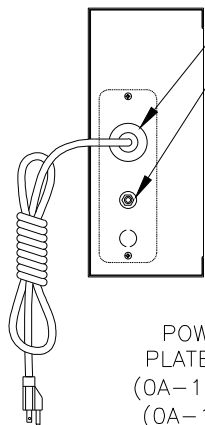
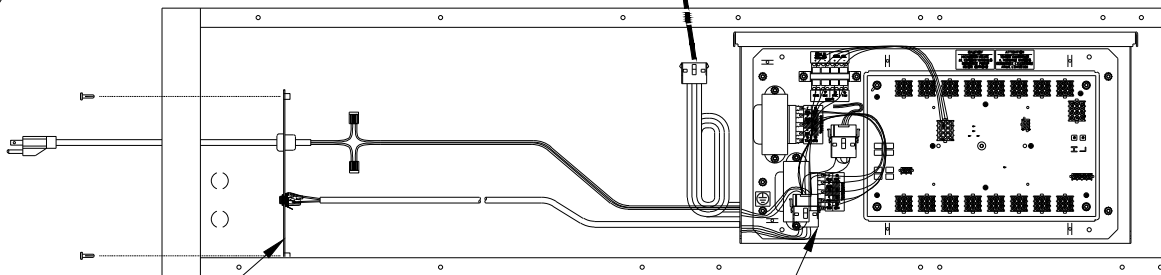

POWER/SIGNAL PLATE, 120V AC (0A-1782-0501) (0A-1153-0105) PRIOR TO APRIL 2015

INSTALL A 2" HOLE PLUG IN THE BOTTOM HOLE OF THE BOTTOM MODULE.

CONNECT THE CABLE FROM THE POWER/SIGNAL PLATE TO THE MATING CONNECTOR HERE.

PROCEDURE

1. MOUNT THE POWER/SIGNAL PLATE IN THE LOWEST MODULE IN THE DISPLAY. REMOVE THE 2" KNOCKOUT AND THE UPPER 7/8" KNOCKOUT FROM THE LEFT END OF THE MODULE, POSITION THE PLATE INSIDE THE END, AND SECURE WITH TWO SCREWS.
2. ROUTE THE CABLE FROM THE POWER/SIGNAL PLATE INTO THE DRIVER ENCLOSURE AND CONNECT THE J51 JACK TO THE MATING P51 PLUG.
3. INSERT 2" BUSHINGS INTO THE HOLES BETWEEN MODULES.
4. PULL THE POWER/SIGNAL CABLE FROM THE LOWER MODULE UP INTO THE NEXT MODULE AND CONNECT THE J51 JACK TO THE MATING P51 PLUG.
5. REPEAT THIS CONNECTION FOR THE OTHER MODULES.
6. CONNECT THE POWER CORD TO 120V AC POWER, AND CONNECT SIGNAL TO THE 1/4" PHONE JACK IN THE END OF THE BOTTOM MODULE.
7. REPLACE COVERS AND PANELS.

	DAKTRONICS, INC. BROOKINGS, SD 57006		THE CONCEPTS EXPRESSED AND DETAILS SHOWN ON THIS DRAWING ARE CONFIDENTIAL AND PROPRIETARY. DO NOT REPRODUCE BY ANY MEANS WITHOUT THE EXPRESS WRITTEN CONSENT OF DAKTRONICS, INC. COPYRIGHT 2015 DAKTRONICS, INC.	
	DO NOT SCALE DRAWING			
PROJ: LED AQUATICS SCOREBOARD				
TITLE: ELECTRICAL HOOKUP- INDOOR DISPLAY- 120V				
DESIGN: AVB		DRAWN: A VANBEMMEL		DATE: 10 APR 00
SCALE: 1=10				
SHEET	REV	JOB NO:	FUNC-TYPE-SIZE	130661
	03	P 1153	R - 10 - A	

03	10 APR 15	UPDATED DIGIT DRIVER SWAPPED 12-PIN PLUG WITH 5-PIN ADDED WAGO PARTS	BJG
02	02 JUN 03	CHANGED DIGIT PATTERN TO G3 CHANGED DRIVER ENCLOSURE	MGL
01	15 JAN 02	CHANGED PUNCH PATTERN	ALG

2-LINE MODULE (SHOWN WITH THE LOWER LEFT PANELS REMOVED)

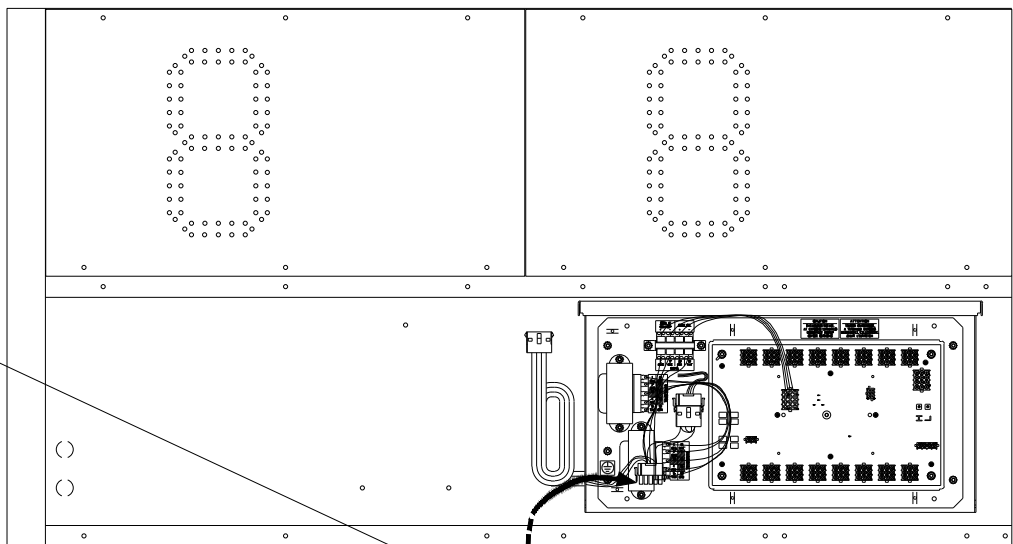

INSTALL A 2" BUSHING IN THE BOTTOM HOLE OF EACH MODULE BEFORE ROUTING WIRES. (IF NOT ALREADY INSTALLED)

REMOVE THE 2" AND UPPER 7/8" KNOCKOUTS FROM THE LEFT SIDE OF THE MODULE.

ROUTE THE CABLE FROM EACH MODULE UP INTO THE NEXT MODULE AND CONNECT TO THE MATING CONNECTOR.

1-LINE MODULE (SHOWN WITH THE LEFT FRONT PANELS REMOVED)

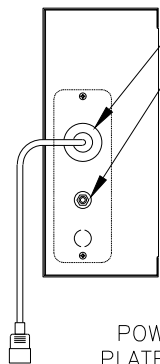
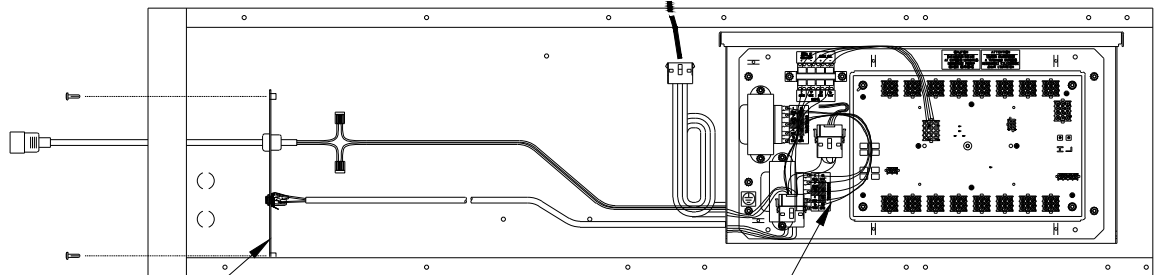

POWER/SIGNAL PLATE, 230V AC (0A-1782-0502) (0A-1153-0106) PRIOR TO APRIL 2015

INSTALL A 2" HOLE PLUG IN THE BOTTOM HOLE OF THE BOTTOM MODULE.

CONNECT THE CABLE FROM THE POWER/SIGNAL PLATE TO THE MATING CONNECTOR HERE.

PROCEDURE

1. MOUNT THE POWER/SIGNAL PLATE IN THE LOWEST MODULE IN THE DISPLAY. REMOVE THE 2" KNOCKOUT AND THE UPPER 7/8" KNOCKOUT FROM THE LEFT END OF THE MODULE, POSITION THE PLATE INSIDE THE END, AND SECURE WITH TWO SCREWS.
2. ROUTE THE CABLE FROM THE POWER/SIGNAL PLATE INTO THE DRIVER ENCLOSURE AND CONNECT THE J51 JACK TO THE MATING P51 PLUG.
3. INSERT 2" BUSHINGS INTO THE HOLES BETWEEN MODULES.
4. PULL THE POWER/SIGNAL CABLE FROM THE LOWER MODULE UP INTO THE NEXT MODULE AND CONNECT THE J51 JACK TO THE MATING P51 PLUG.
5. REPEAT THIS CONNECTION FOR THE OTHER MODULES.
6. CONNECT THE POWER CORD TO 230V AC POWER, AND CONNECT SIGNAL TO THE 1/4" PHONE JACK IN THE END OF THE BOTTOM MODULE.
7. REPLACE COVERS AND PANELS.

	DAKTRONICS, INC. BROOKINGS, SD 57006		THE CONCEPTS EXPRESSED AND DETAILS SHOWN ON THIS DRAWING ARE CONFIDENTIAL AND PROPRIETARY. DO NOT REPRODUCE BY ANY MEANS WITHOUT THE EXPRESS WRITTEN CONSENT OF DAKTRONICS, INC. COPYRIGHT 2015 DAKTRONICS, INC.	
	DO NOT SCALE DRAWING			
PROJ: LED AQUATICS SCOREBOARD				
TITLE: ELECTRICAL HOOKUP- INDOOR DISPLAY- 230V				
DESIGN: AVB		DRAWN: A VANBEMMEL		DATE: 10 APR 00
SCALE: 1=10				
SHEET	REV	JOB NO:	FUNC-TYPE-SIZE	130676
	03	P 1153	R - 10 - A	

03	10 APR 15	UPDATED DIGIT DRIVER SWAPPED 12-PIN PLUG WITH 5-PIN ADDED WAGO PARTS	BJG
02	02 JUN 03	CHANGED DIGIT PATTERN TO G3 CHANGED DRIVER ENCLOSURE	MGL
01	15 JAN 02	CHANGED PUNCH PATTERN	ALG

01	15 JAN 02	CHANGED PUNCH PATTERN	ALG
02	02 JUN 03	CHANGED DIGIT PATTERN TO G3 CHANGED DRIVER ENCLOSURE	MGL
03	10 APR 15	UPDATED DIGIT DRIVER SWAPPED 12-PIN PLUG WITH 5-PIN	BJG

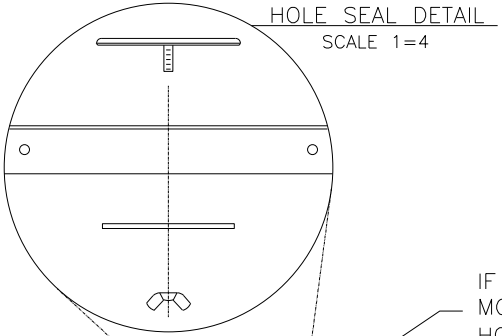

THE DISPLAY SHOWN IS A 6-LINE HORIZONTAL DISPLAY, MODEL SW-2106, WITH A MODEL SW-2006 EVENT/HEAT MODULE ATOP THE LEFT SIDE. MODELS VARY IN CONFIGURATION, AND EACH INSTALLATION MAY BE DIFFERENT, DEPENDING ON OPTIONAL EQUIPMENT. THE WIRING METHOD IS THE SAME FOR ALL MODELS.

IF THE TOP SECTION IS A DIGIT MODULE, INSTALL THE 3-PIECE HOLE SEAL (HS-1332) IN THE TOP.

IF THE TOP SECTION IS A CAPTION MODULE OR AN AD PANEL, INSTALL A PLASTIC HOLE PLUG IN THE TOP.

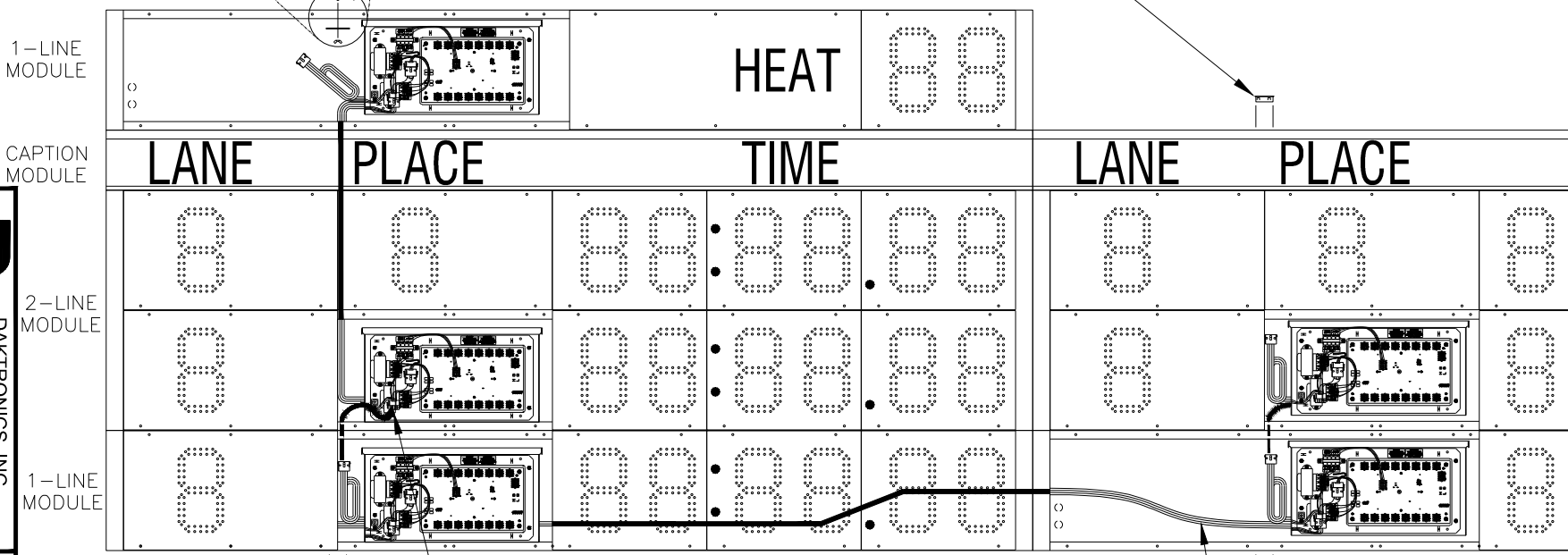

1-LINE MODULE

CAPTION MODULE

2-LINE MODULE

1-LINE MODULE

FRONT VIEW
SOME PANELS REMOVED TO SHOW INTERIOR

INSTALL A PLASTIC HOLE PLUG (HS-1056) IN EACH BOTTOM HOLE.

EACH DIGIT MODULE HAS A CABLE TO BE ROUTED UP TO THE NEXT SECTION. CONNECT THE J51 JACK TO THE MATING P51 PLUG IN THE DRIVER ENCLOSURE.

ON HORIZONTAL DISPLAYS, INSTALL THE INTERCONNECT CABLE (0A-1782-0227) (0A-1153-0122 PRIOR TO APRIL 2015) FROM THE BOTTOM LEFT DIGIT MODULE TO THE BOTTOM RIGHT DIGIT MODULE. CONNECT THE J52 JACK TO THE MATING P51 PLUG.



THE CONCEPTS EXPRESSED AND DETAILS SHOWN ON THIS DRAWING ARE CONFIDENTIAL AND PROPRIETARY. DO NOT REPRODUCE BY ANY MEANS WITHOUT THE EXPRESS WRITTEN CONSENT OF DAKTRONICS, INC. COPYRIGHT 2015 DAKTRONICS, INC.

PROJ: LED AQUATICS SCOREBOARD		DRAWN: A VANBEMMEL		DATE: 11 APR 00	
TITLE: INTERNAL CABLE ROUTING		DESIGN: SCALE: 1=20		SHEET	
SHEET		REV		JOB NO:	
03		P1153		FUNC-TYPE-SIZE	
R-10-A				130679	

CTS TIMER WIRED USING COLORADO SIGNAL CABLE

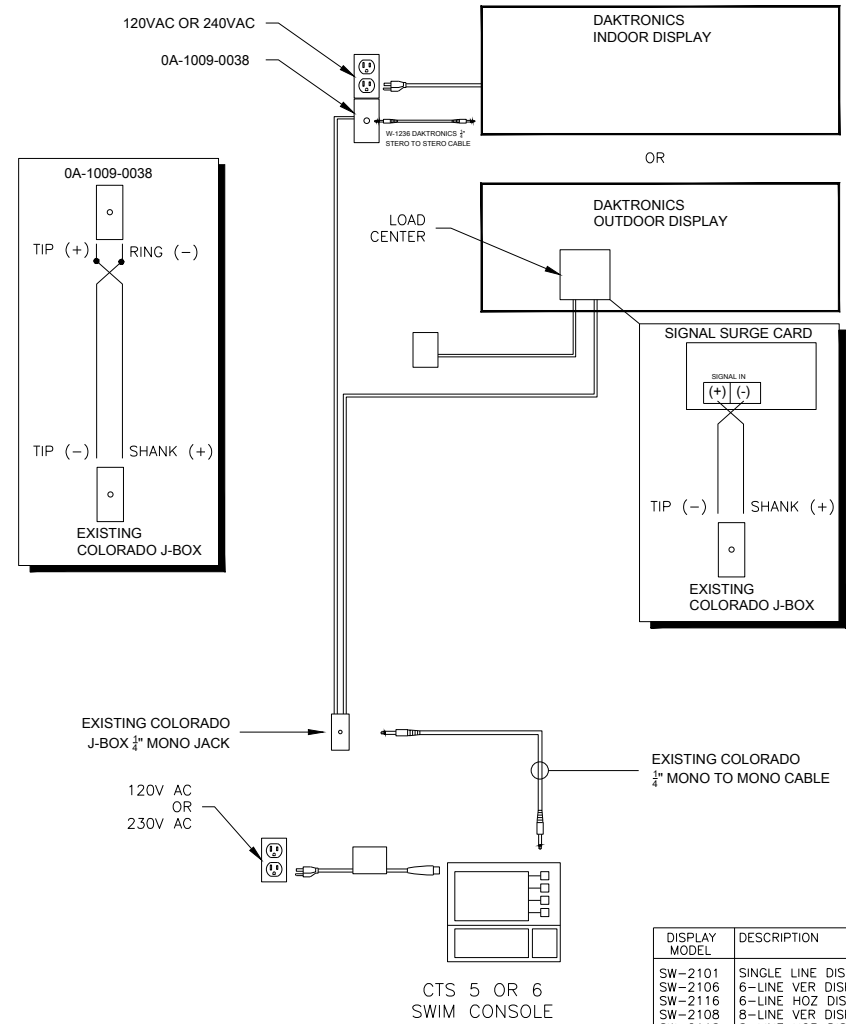

CTS TIMER WIRED WITH DAKTRONICS SIGNAL CABLE

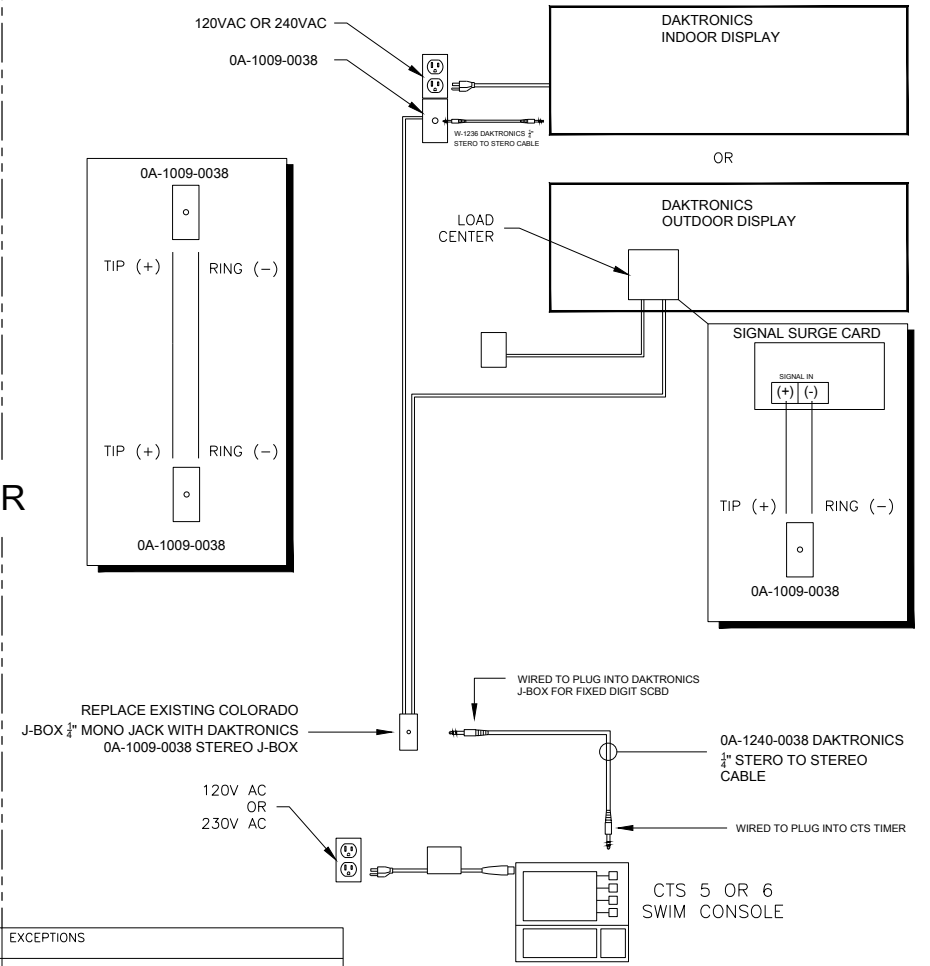

DISPLAY MODEL	DESCRIPTION	EXCEPTIONS
SW-2101	SINGLE LINE DISPLAY	DISPLAYS SWIMMING INFO ONLY
SW-2106	6-LINE VER DISPLAY	
SW-2116	6-LINE HOZ DISPLAY	
SW-2108	8-LINE VER DISPLAY	
SW-2118	8-LINE HOR DISPLAY	
SW-2110	10-LINE VER DISPLAY	
SW-2120	10-LINE HOR DISPLAY	NON
SW-2206	6-LINE MULTI-SPORT VER DISPLAY	CTS TIMER WILL NOT OPERATE D.D DIGITS ON MULTI-SPORT LINE IN DIVING MODE.
SW-2216	6-LINE MULTI-SPORT HOZ DISPLAY	
SW-2208	8-LINE MULTI-SPORT VER DISPLAY	
SW-2218	8-LINE MULTI-SPORT HOR DISPLAY	
SW-2210	10-LINE MULTI-SPORT VER DISPLAY	
SW-2220	10-LINE MULTI-SPORT HOR DISPLAY	
		ADDRESSED CORRECTLY IT WILL SOUND THE HORN FOR WATERPOLO. REFER TO THE DISPLAY MANUAL FOR ADDRESSING.

REV 01	DATE: 27 NOV 2013	UPDATED SIGNAL CONNECTION FROM TIMER TO SCBD ADDED TWO DIFFERENT METHODS OF CONNECTION	BY: CME
DAKTRONICS, INC. BROOKINGS, SD 57006		THE CONCEPTS EXPRESSED AND DETAILS SHOWN ON THIS DRAWING ARE CONFIDENTIAL AND PROPRIETARY. DO NOT REPRODUCE BY ANY MEANS WITHOUT THE EXPRESSED WRITTEN CONSENT OF DAKTRONICS, INC. COPYRIGHT 2013 DAKTRONICS, INC.	
DO NOT SCALE DRAWING			
PROJECT: LED AQUATICS SCOREBOARD			
TITLE: RISER DIAGRAM- WITH CTS TIMER			
DESIGN: AVB	DRAWN: DWEIBEL		DATE: 14 APR 00
SCALE: NONE			
SHEET	REV 01	JOB NO. P1153	FUNC-TYPE-SIZE R-03-A
			130979

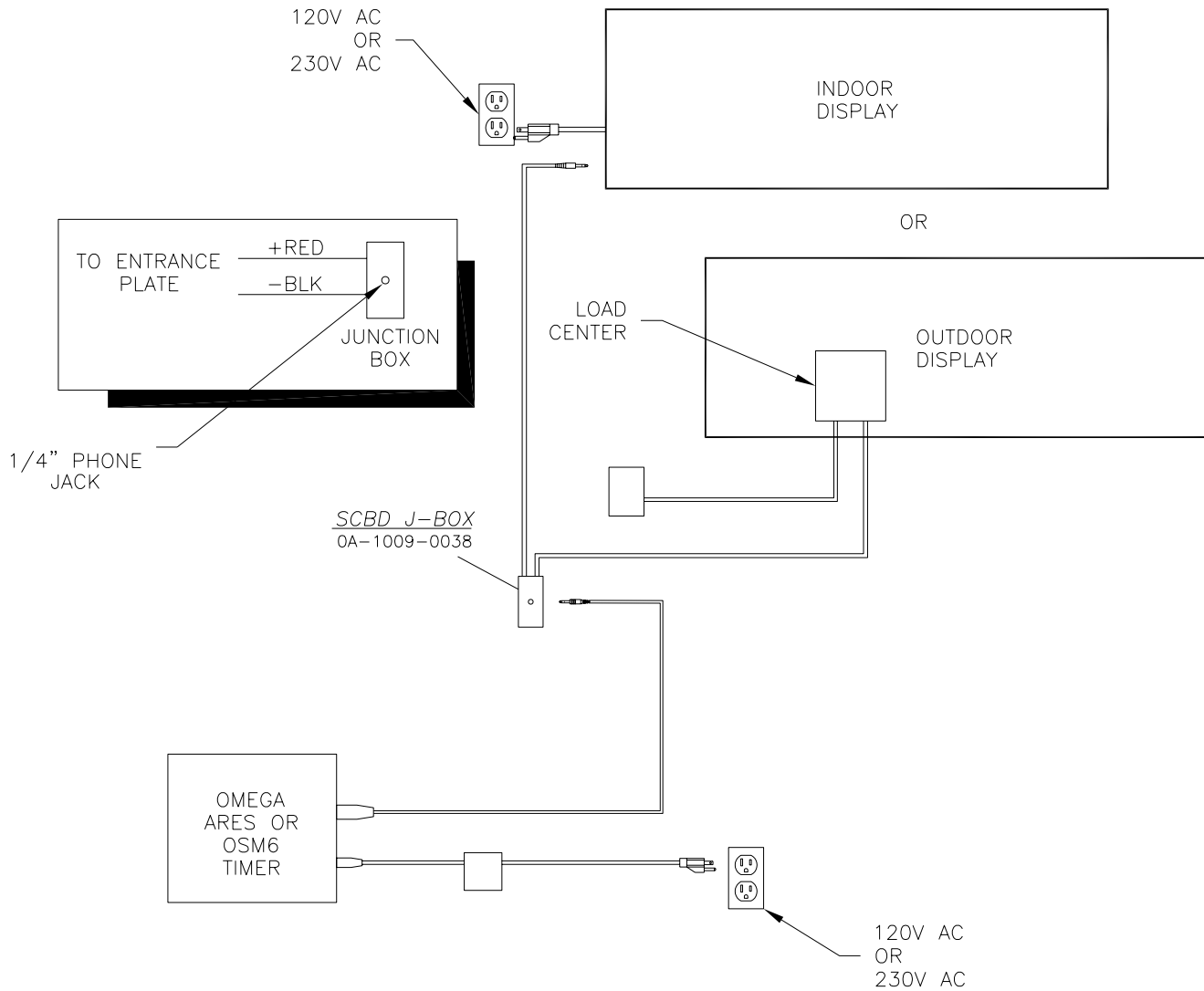

MODEL	OMEGA TIMERS
SW-2101	SEE NOTE 1
SW-2106	MULTI-LINE
SW-2116	MULTI-LINE
SW-2108	MULTI-LINE
SW-2118	MULTI-LINE
SW-2110	MULTI-LINE
SW-2120	MULTI-LINE
MS-2206	SEE NOTE 2
MS-2216	SEE NOTE 2
MS-2208	SEE NOTE 2
MS-2218	SEE NOTE 2
MS-2210	SEE NOTE 2
MS-2220	SEE NOTE 2
SW-2004	SEE NOTE 3
SW-2005	SEE NOTE 3
SW-2006	SEE NOTE 3
SW-2007	SEE NOTE 3
SW-2008	SEE NOTE 3
SW-2009	SEE NOTE 3

- NOTES:
1. SET ADDRESS TO 1.
 2. OPERATES IN SWIM MODE ONLY.
 3. FOR OSM6, USE ALLSPORT 4000 CONTROLLER IN CODE 244.

DAKTRONICS, INC. BROOKINGS, SD 57006

PROJ: LED AQUATICS / TRACK DISPLAYS

TITLE: RISER DIAGRAM, WITH OMEGA TIMER

DES. BY: AVB DRAWN BY: DWEIBEL DATE: 19 APR 00

REVISION	APPR. BY:	1153-R03A-131037
	SCALE: NONE	

REV.	DATE	DESCRIPTION	BY	APPR.

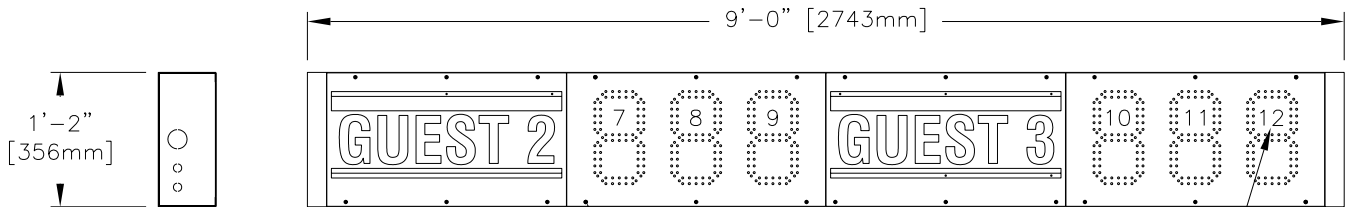

FRONT VIEW

REMOVE THESE SCREWS TO OPEN THE PANEL AND GAIN ACCESS TO INTERNAL COMPONENTS.

NUMBERS ON DIGITS INDICATE WHICH DRIVER CONNECTOR IS WIRED TO THAT DIGIT.

CABLE CONNECTS TO THE NEXT SECTION

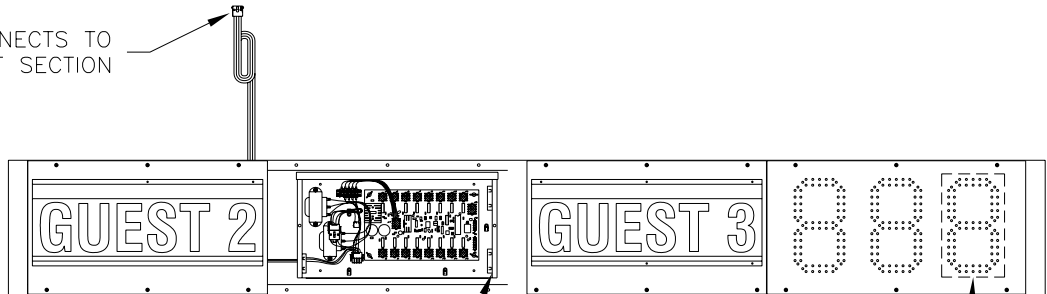

FRONT VIEW

SHOWN WITH PANEL AND ENCLOSURE COVER REMOVED

DIGIT CIRCUIT BOARD BEHIND PANEL

DRIVER ENCLOSURE

MODEL:

- SW-2009-13 120V AC, INDOOR
- SW-2009-14 230V AC, INDOOR
- SW-2009-11 120V AC, OUTDOOR
- SW-2009-12 230V AC, OUTDOOR

MAX POWER DEMAND: 200 W

THE CONCEPTS EXPRESSED AND DETAILS SHOWN ON THIS DRAWING ARE CONFIDENTIAL AND PROPRIETARY. DO NOT REPRODUCE BY ANY MEANS, INCLUDING ELECTRONICALLY WITHOUT THE EXPRESSED WRITTEN CONSENT OF DAKTRONICS, INC. COPYRIGHT 2003 DAKTRONICS, INC.

DAKTRONICS, INC. BROOKINGS, SD 57006

PROJ: LED AQUATICS / TRACK DISPLAYS

TITLE: ELEC SPEC, SW-2009-13, -14, -11, & -12

DES. BY: AVB

DRAWN BY: A VANBEMMEL DATE: 18 APR 00

REVISION

APPR. BY:

SCALE: 1=20

1153-R04A-131039

REV.	DATE	DESCRIPTION	BY	APPR.
02	02 JUN 03	CHANGED DIGIT PATTERN TO G3 CHANGED DRIVER ENCLOSURE	MGL	
01	15 JAN 02	DELETED OUTDOOR DISPLAY, AND PART NUMBER TABLE.	ALG	

TRACK SYSTEM RISER DIAGRAM
FOOTBALL/TRACK SCBD WITH
OMNISPORT 2000, TRACK SIDE

Ⓐ SCOREBOARD SIGNAL CABLE OPTIONS:
- W-1234, 2 PAIR SIGNAL CABLE.
CONDUIT REQUIRED.

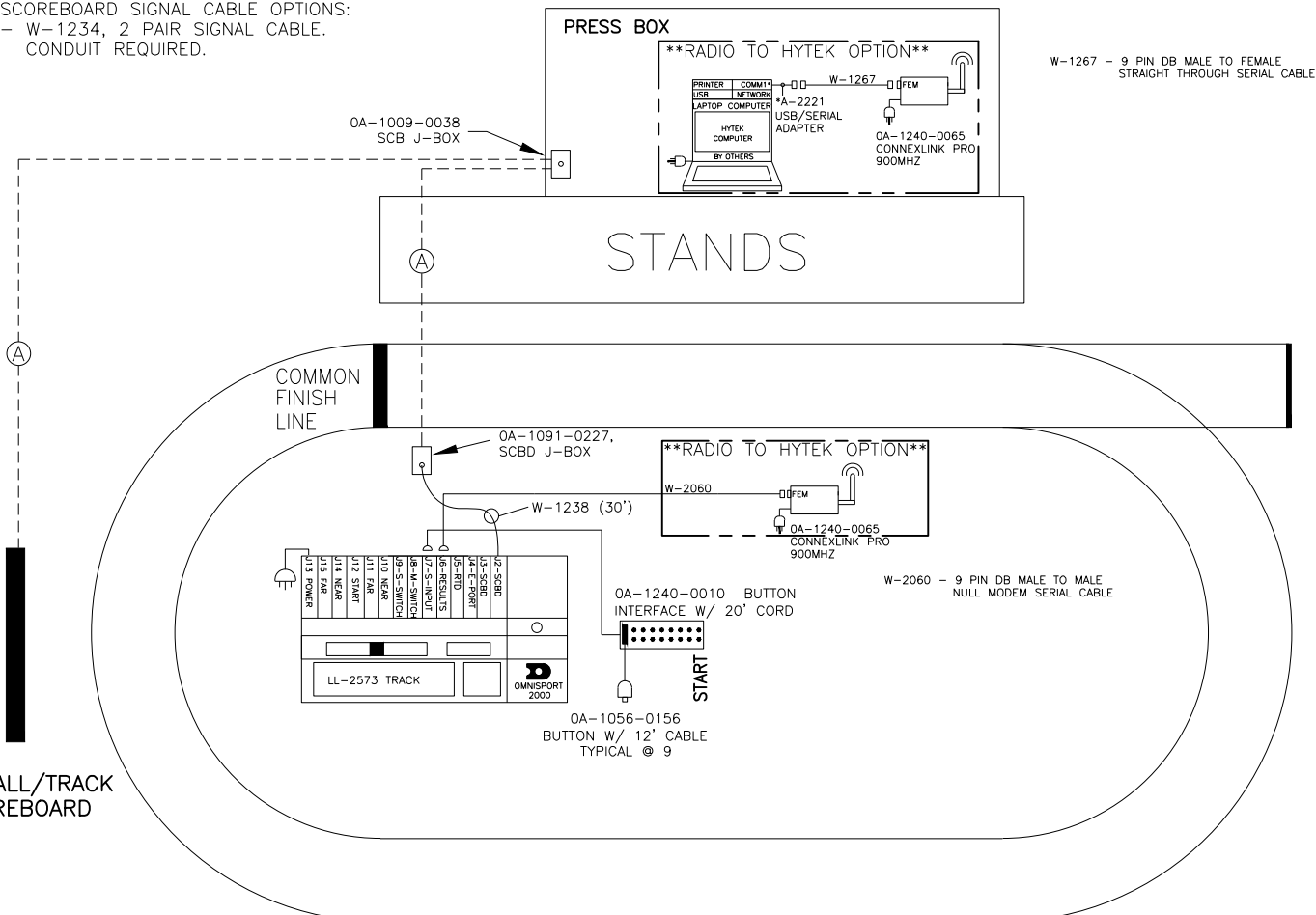

- TRACK EQUIPMENT BOM:**
- OA-1240-0082 OMNISPORT 2000E (TRACK TIMER) @ 1
 - W-1238 30' SIGNAL CABLE @ 1
 - OA-1091-0227 TRACK SIDE J-BOX @ 1
 - OA-1240-0010 BUTTON INTERFACE @ 1
 - OA-1056-0156 12' PUSH BUTTON @ 9

- DIP SWITCH SETTINGS FOR CONNEXLINK PRO RADIO'S**
- CLIENT #1 ON, #2,3,4,5,6 OFF
 - SERVER #1,5 ON, #2,3,4,6 OFF
- REFER TO SL-04370 FOR ADDITIONAL INFORMATION AS NEEDED.

-IF MORE THAN 8 LANES ARE REQUIRED, OR MORE THAN 1 BUTTON PER LANE, REPLACE OA-1240-0010 WITH OA-1240-0016 AND ORDER THE NUMBER OF BUTTONS NEEDED.

REV 07	DATE: 02 AUG 13	ADDED SL-NOTE AND OMNI PART NUMBER TO HELP CLEAN UP DRAWING TO COMBINE FB/TR INTO ONE DRAWING. DWG 186548 WAS INACTIVATED.	BY: HBB
REV 08	DATE: 23 MAR 15	CHANGED RADIO'S TO CONNEXLINK PRO AND UPDATED CABLES BETWEEN HY-TEK AND OMNISPORT	BY: HBB

DAKTRONICS, INC.
BROOKINGS, SD 57006

PROJ: OMNISPORT 2000
TITLE: SYSTEM RISER: FB/TRACK SCBD W/ OMNI2K- TRACK SIDE
DESIGN: MILLER
SCALE: NONE
SHEET: 08

DATE: 08 APR 03
JOB NO.: P1240
FUND-TYPE-SIZE: R-01-A
186535

NO	REV	DATE	DESCRIPTION
01			ISSUED FOR CONSTRUCTION
02			ISSUED FOR CONSTRUCTION
03			ISSUED FOR CONSTRUCTION
04			ISSUED FOR CONSTRUCTION
05			ISSUED FOR CONSTRUCTION
06			ISSUED FOR CONSTRUCTION
07			ISSUED FOR CONSTRUCTION
08			ISSUED FOR CONSTRUCTION

THE CONCEPTS EXPRESSED AND DETAILS SHOWN ON THIS DRAWING ARE CONFIDENTIAL AND PROPRIETARY. DO NOT REPRODUCE BY ANY MEANS WITHOUT THE EXPRESSED WRITTEN CONSENT OF DAKTRONICS, INC. COPYRIGHT 2011 DAKTRONICS, INC.

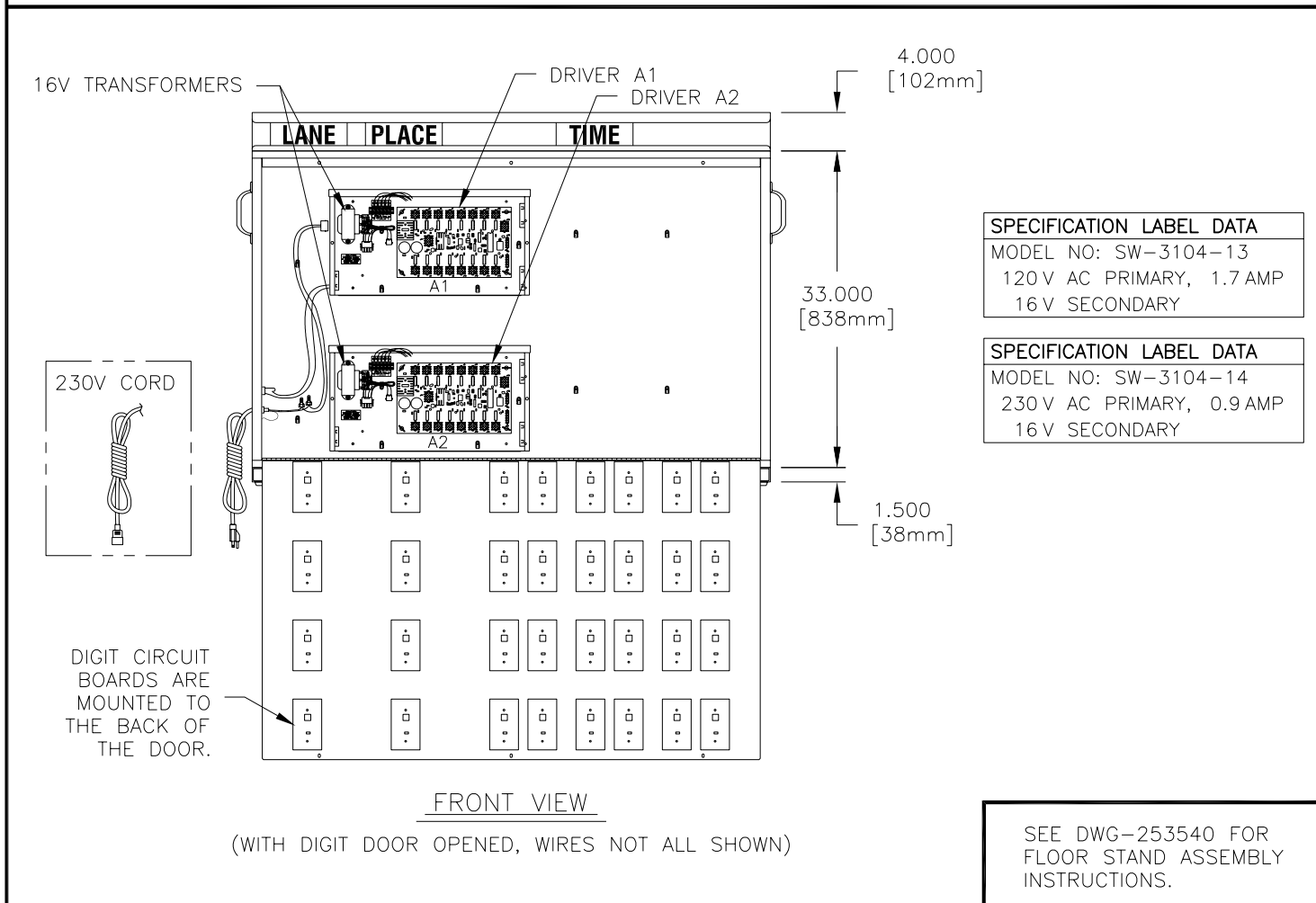
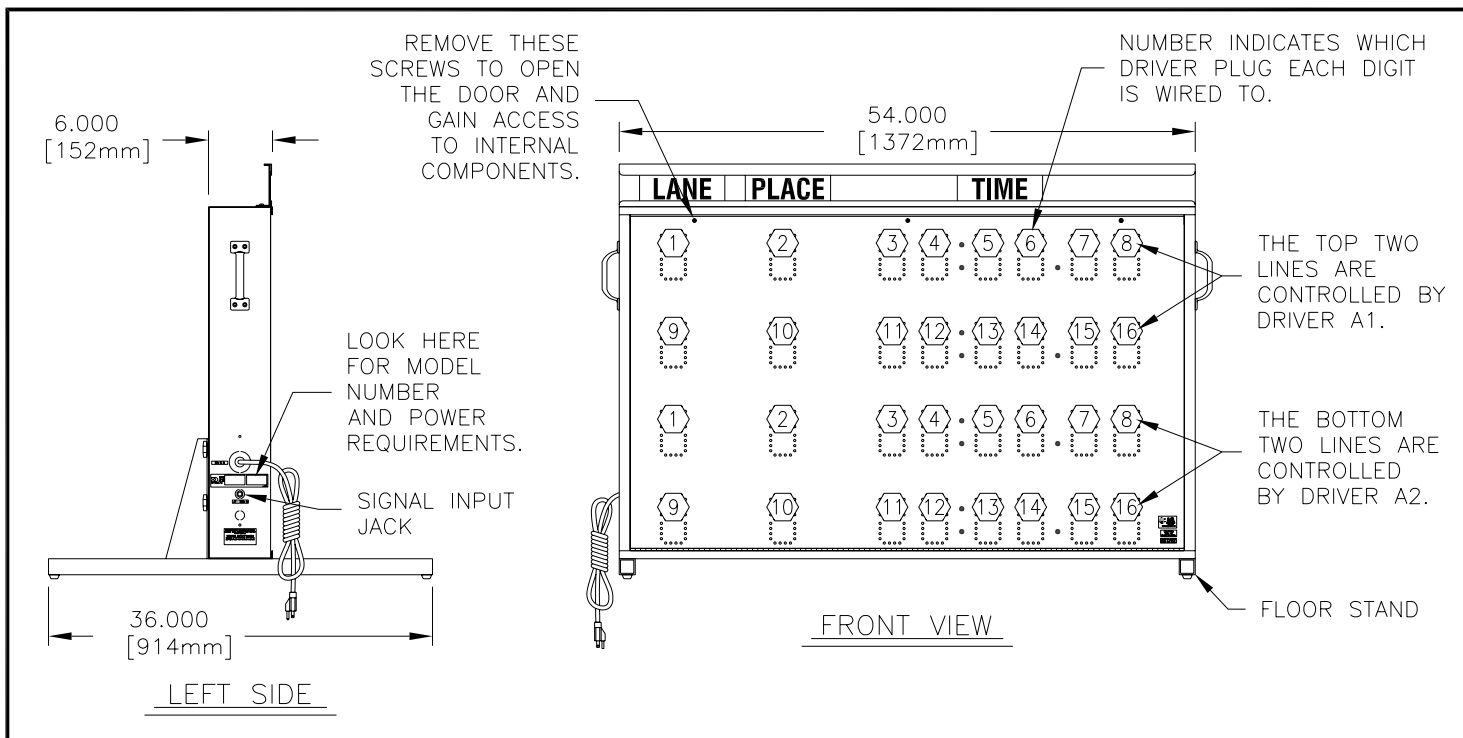

(WITH DIGIT DOOR OPENED, WIRES NOT ALL SHOWN)

THE CONCEPTS EXPRESSED AND DETAILS SHOWN ON THIS DRAWING ARE CONFIDENTIAL AND PROPRIETARY. DO NOT REPRODUCE BY ANY MEANS, INCLUDING ELECTRONICALLY WITHOUT THE EXPRESSED WRITTEN CONSENT OF DAKTRONICS, INC. COPYRIGHT 2005 DAKTRONICS, INC.				
DAKTRONICS, INC. BROOKINGS, SD 57006				
PROJ:				
TITLE: SHOP DRAWING, SW-3104				
DES. BY:		DRAWN BY: M LEOPOLD		DATE: 05 DEC 05
REVISION	APPR. BY:	1153-R04A-258712		
00	SCALE: 1=18			

REV.	DATE	DESCRIPTION	BY	APPR.

RADIO INSTALLATION

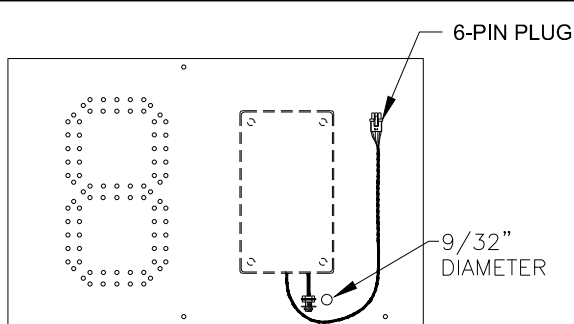
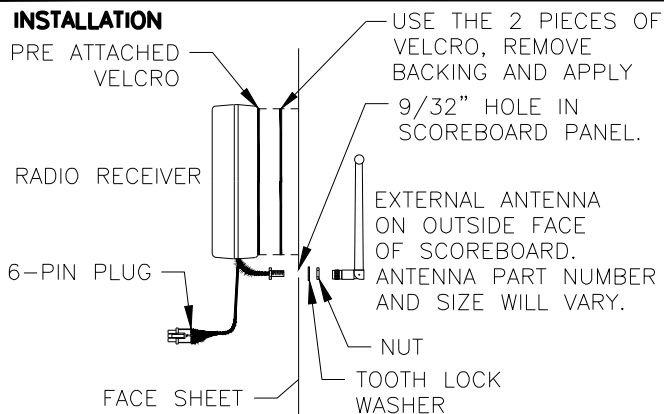

GYRUS VIEW

INDOOR SCOREBOARD

1-LINE MODULE (SHOWN WITH THE LEFT FRONT PANELS REMOVED)

ROUTE THE CABLE FROM EACH MODULE UP INTO THE NEXT MODULE AND CONNECT TO THE MATING CONNECTOR.

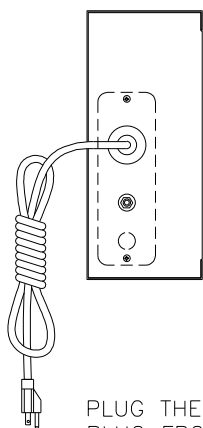

PLUG THE 6-PIN MALE PLUG FROM THE RADIO RECEIVER INTO THE MATING 6-PIN JACK (J21) ON THE DRIVER PCB AS SHOWN.

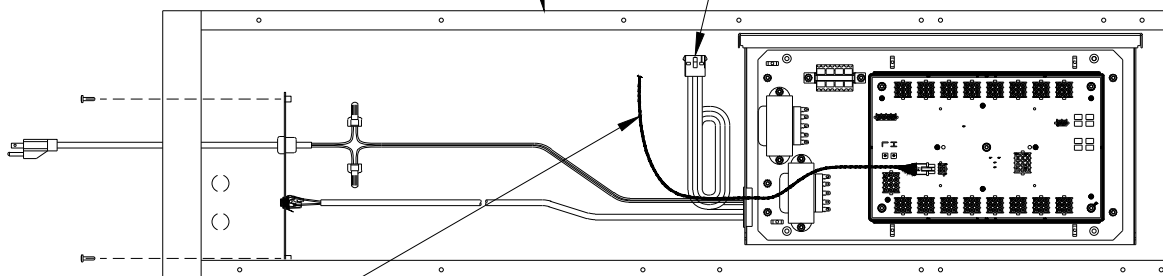

OUTDOOR SCOREBOARD

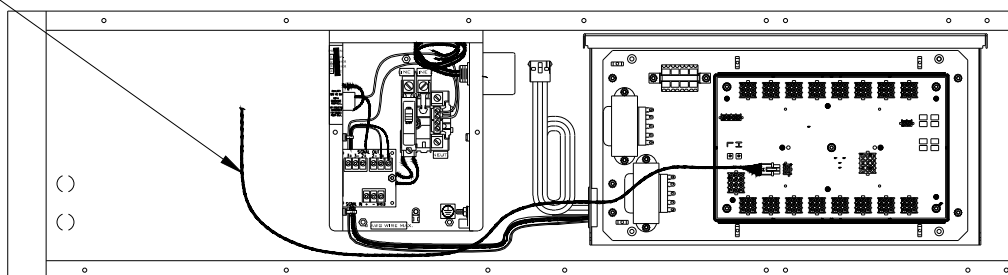

LEGACY VIEW

PLUG THE 6-PIN MALE PLUG FROM THE RADIO RECEIVER INTO THE MATING 6-PIN JACK OF THE ADAPTOR HARNESS (W-2913).
 PLUG THE MALE 5-PIN END OF THE ADAPTER HARNESS INTO THE MATING 5-PIN CONNECTOR (J45) COMING FROM THE DRIVER.

W-2913

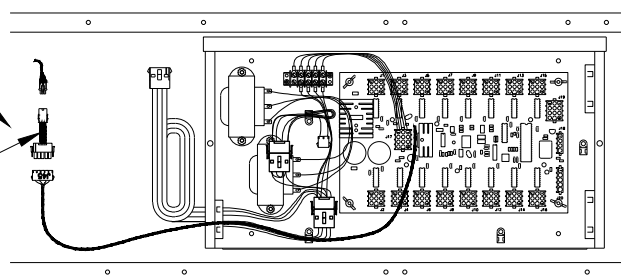

NOTE:

WHEN INSTALLING A RADIO IN A HORIZONTAL BOARD, MOVE THE RED WIRE ON THE DRIVER TB31 FROM PIN 3 TO PIN 1.

 DAKTRONICS, INC. BROOKINGS, SD 57006 DO NOT SCALE DRAWING	THE CONCEPTS EXPRESSED AND DETAILS SHOWN ON THIS DRAWING ARE CONFIDENTIAL AND PROPRIETARY. DO NOT REPRODUCE BY ANY MEANS WITHOUT THE EXPRESSED WRITTEN CONSENT OF DAKTRONICS, INC. COPYRIGHT 2010 DAKTRONICS, INC.		
	PROJ.: LED AQUATICS / TRACK DISPLAYS TITLE: AQUATICS- RADIO HOOKUP		
DESIGN:	DRAWN: AGORDER	DATE: 17 MAY 07	
SCALE: NONE			
SHEET	REV	JOB NO:	FUNC-TYPE-SIZE
	03	P1153	R-10-A
			305509

REV 03	DATE: 3 MAR 15	UPDATED WITH GYRUS AND ADAPTOR HARNESS VIEWS	BY: KCS
REV 02	DATE: 22 MAR 11	UPDATED DRIVER PART NUMBER	BY: KZB
REV 01	DATE: 19 DEC 07	ADDED OUTDOOR SCOREBOARD AND REWIRING OF DRIVER FOR HORIZONTAL BOARDS.	BY: AMG

230V MODULE SCHEMATIC

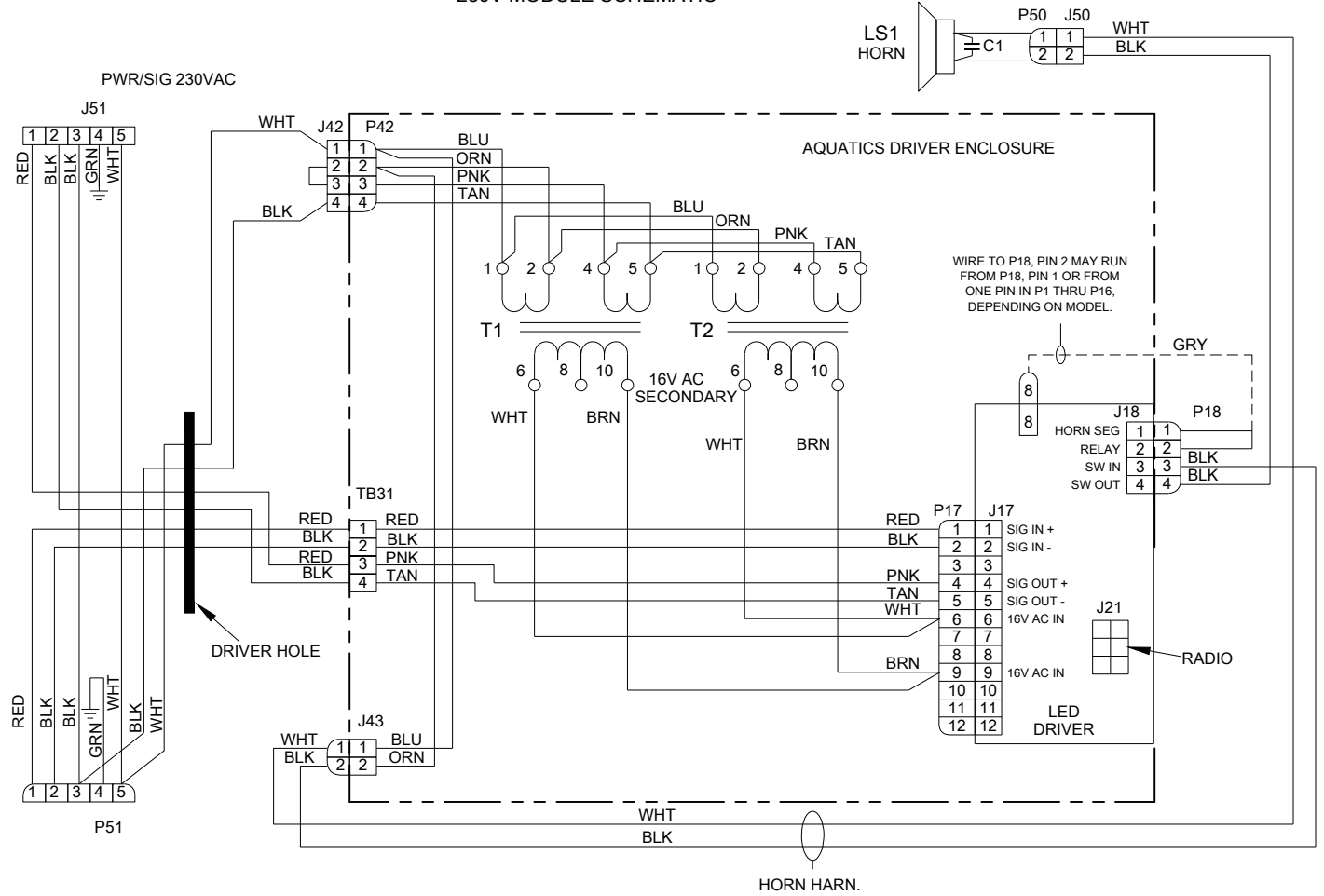

NOTES:

-HORN AND HORN HARNESS SHOWN IS OPTIONAL. CHECK ASSEMBLY PACKET TO SEE IF IT IS REQUIRED.

-REFER TO POWER AND ADDRESS DRAWING TO SET CORRECT ADDRESS

-SEE ASSEMBLY PACKET AND DRAWINGS FOR ALL PART NUMBERS

230V INPUT SCHEMATIC

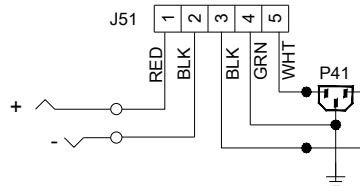

LOAD CENTER INPUT SCHEMATIC

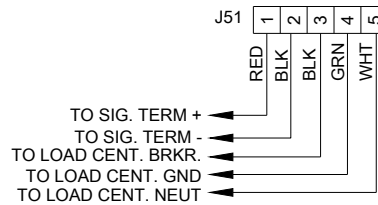

DAKTRONICS, INC.
BROOKINGS, SD 57006

THE CONCEPTS EXPRESSED AND DETAILS SHOWN ON THIS DRAWING ARE CONFIDENTIAL AND PROPRIETARY. DO NOT REPRODUCE BY ANY MEANS WITHOUT THE EXPRESS WRITTEN CONSENT OF DAKTRONICS, INC. COPYRIGHT 2015 DAKTRONICS, INC.

DO NOT SCALE DRAWING

PROJ: AQUATICS

TITLE: SCHEMATIC; 1 DRIVER, 230VAC

DESIGN: JLAIRD

DRAWN: JLAIRD

DATE: 03 APR 15

SCALE: NONE

SHEET	REV	JOB NO:	FUNC -TYPE-SIZE	3033884
	00	P 1153	R - 03 - A	

120V MODULE SCHEMATIC

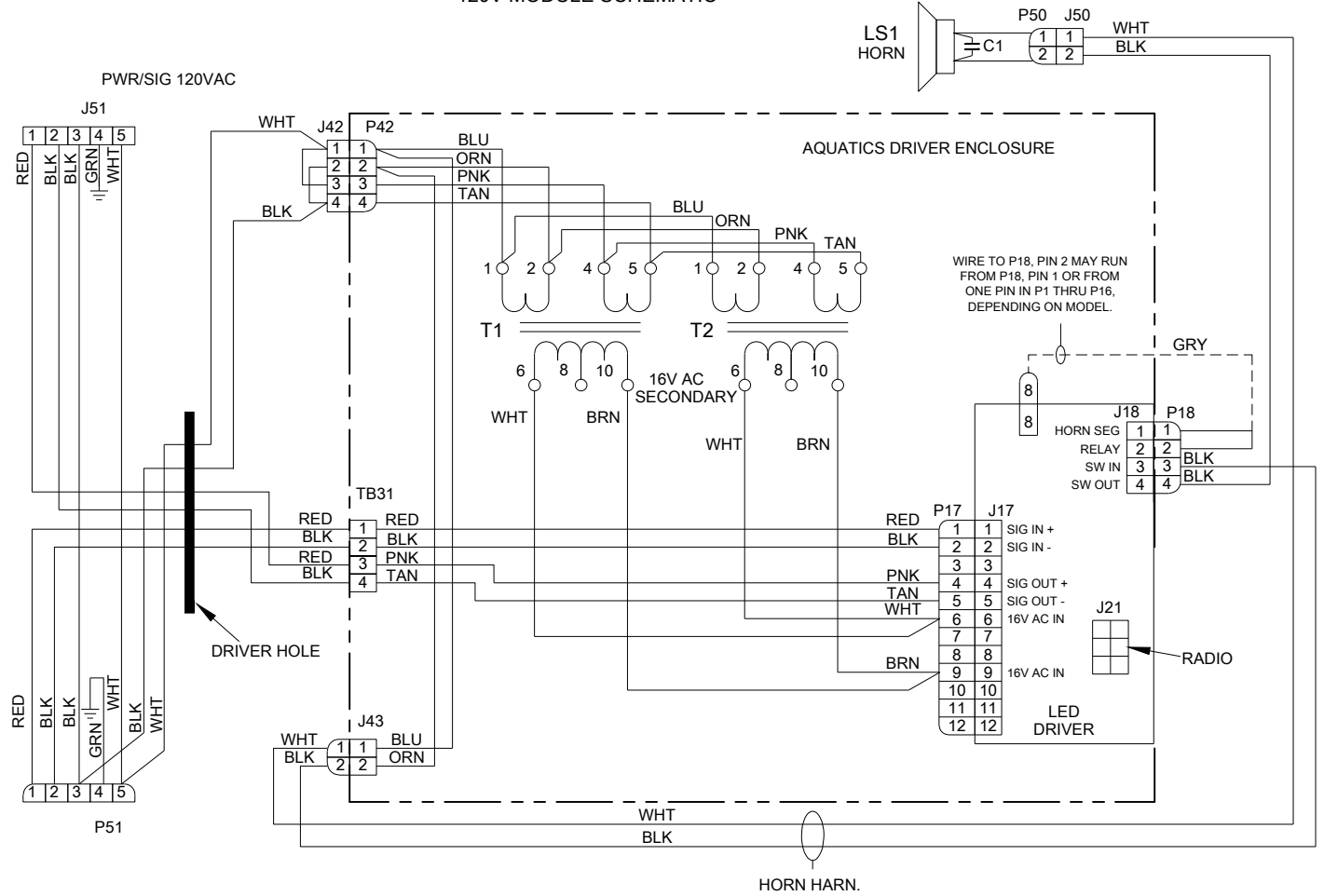

NOTES:

-HORN AND HORN HARNESS SHOWN IS OPTIONAL. CHECK ASSEMBLY PACKET TO SEE IF IT IS REQUIRED.

-REFER TO POWER AND ADDRESS DRAWING TO SET CORRECT ADDRESS

-SEE ASSEMBLY PACKET AND DRAWINGS FOR ALL PART NUMBERS

120V INPUT SCHEMATIC

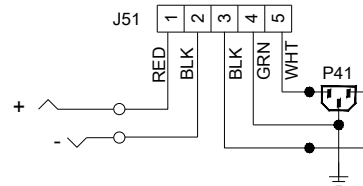

LOAD CENTER INPUT SCHEMATIC

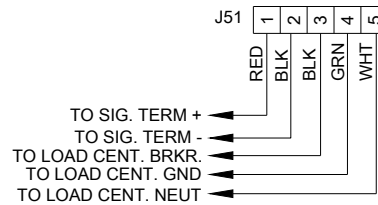

DAKTRONICS, INC.
 BROOKINGS, SD 57006

THE CONCEPTS EXPRESSED AND DETAILS SHOWN ON THIS DRAWING ARE CONFIDENTIAL AND PROPRIETARY. DO NOT REPRODUCE BY ANY MEANS WITHOUT THE EXPRESS WRITTEN CONSENT OF DAKTRONICS, INC.
 COPYRIGHT 2015 DAKTRONICS, INC.

DO NOT SCALE DRAWING

PROJ: AQUATICS

TITLE: SCHEMATIC; 1 DRIVER, 120VAC

DESIGN: JLAIRD

DRAWN: JLAIRD

DATE: 03 APR 15

SCALE: NONE

SHEET 00

REV 00

JOB NO: P1153

FUNC - TYPE - SIZE R - 03 - A

3033885

120VAC SCHEMATIC

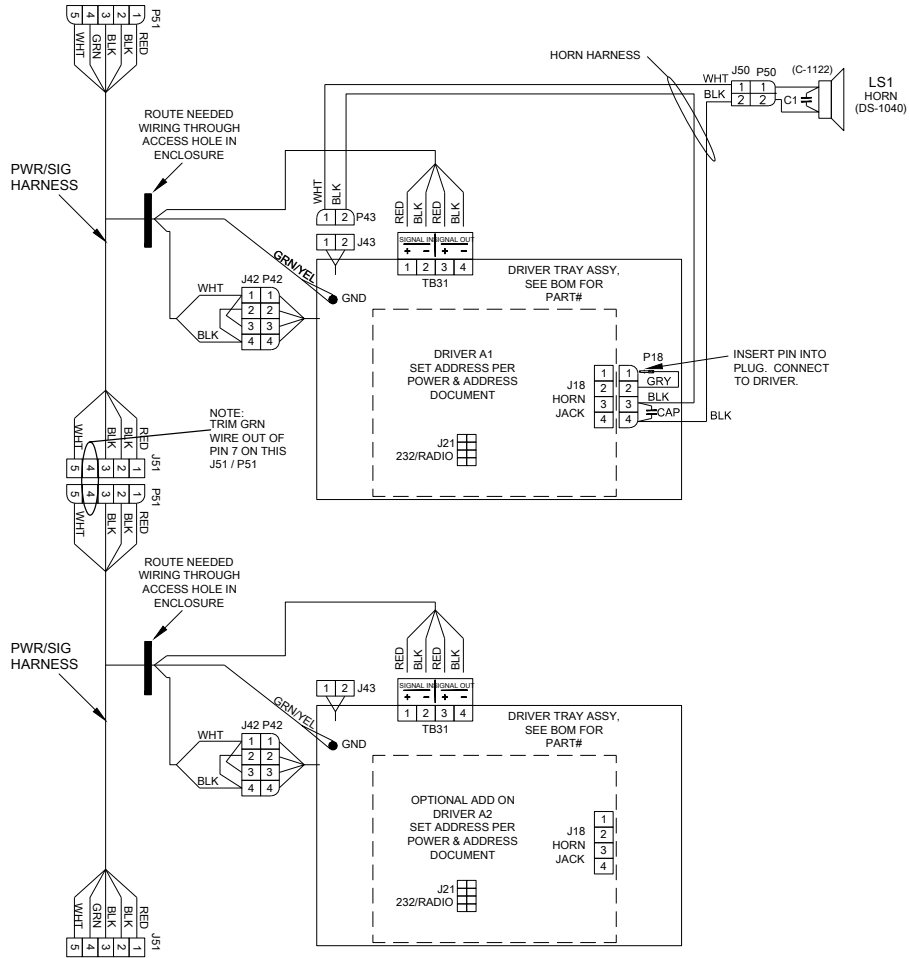

230VAC SCHEMATIC

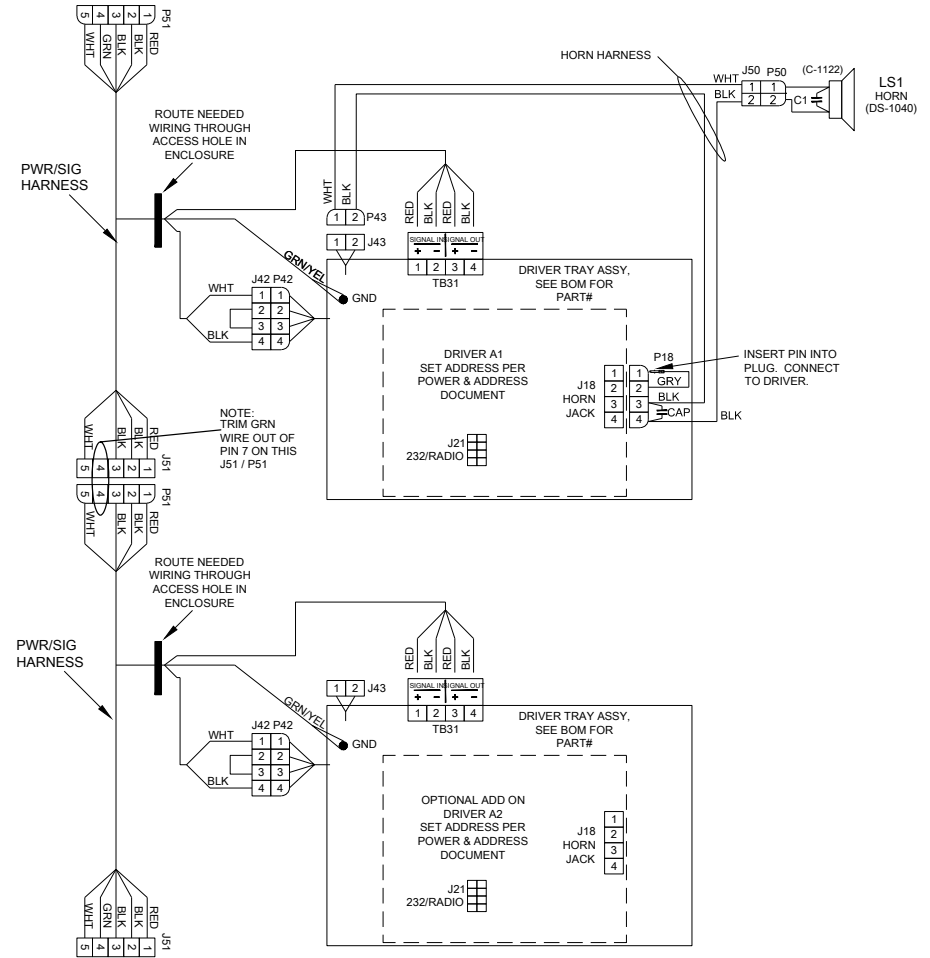

LOAD CENTER INPUT SCHEMATIC

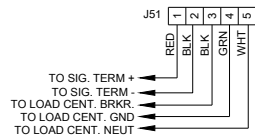

INPUT SCHEMATIC

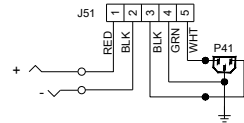

NOTES:

- HORN AND HORN HARNESS SHOWN IS OPTIONAL. CHECK ASSEMBLY PACKET TO SEE IF IT IS REQUIRED.
- SEE ASSEMBLY PACKET AND DRAWINGS FOR ALL PART NUMBERS, AND COMPONENT LOCATION

DAKTRONICS, INC. BROOKINGS, SD 57006		THE CONCEPTS EXPRESSED AND DETAILS SHOWN ON THIS DRAWING ARE CONFIDENTIAL AND PROPRIETARY. DO NOT REPRODUCE BY ANY MEANS WITHOUT THE EXPRESS WRITTEN CONSENT OF DAKTRONICS, INC. COPYRIGHT 2015 DAKTRONICS, INC.	
		DO NOT SCALE DRAWING	
PROJ: AQUATICS			
TITLE: SCHEMATIC; 2 DRIVER AQUATICS SCOREBOARD			
DESIGN: JLAIRD		DRAWN: JLAIRD	
SCALE: NONE		DATE: 17 APR 15	
SHEET	REV 00	JOB NO. P1153	FUNC-TYPE-SIZE E-03-B
			3033887

This page intentionally left blank.

C Daktronics Warranty & Limitation of Liability

This section includes the Daktronics Warranty & Limitation of Liability statement (SL-02374).

This page intentionally left blank.

DAKTRONICS WARRANTY & LIMITATION OF LIABILITY

This Warranty and Limitation of Liability (the "Warranty") sets forth the warranty provided by Daktronics with respect to the Equipment. By accepting delivery of the Equipment, Purchaser and End User agree to be bound by and accept these terms and conditions. Unless otherwise defined herein, all terms within the Warranty shall have the same meaning and definition as provided elsewhere in the Agreement.

DAKTRONICS WILL ONLY BE OBLIGATED TO HONOR THE WARRANTY SET FORTH IN THESE TERMS AND CONDITIONS UPON RECEIPT OF FULL PAYMENT FOR THE EQUIPMENT

1. Warranty Coverage.

- A. Daktronics warrants to the original end user (the "End User", which may also be the Purchaser) that the Equipment will be free from Defects (as defined below) in materials and workmanship for a period of one (1) year (the "Warranty Period"). The Warranty Period shall commence on the earlier of: (i) four weeks from the date that the Equipment leaves Daktronics' facility; or (ii) Substantial Completion as defined herein. The Warranty Period shall expire on the first anniversary of the commencement date.

"Substantial Completion" means the operational availability of the Equipment to the End User in accordance with the Equipment's specifications, without regard to punch-list items, or other non-substantial items which do not affect the operation of the Equipment

- B. Daktronics' obligation under this Warranty is limited to, at Daktronics' option, replacing or repairing, any Equipment or part thereof that is found by Daktronics not to conform to the Equipment's specifications. Unless otherwise directed by Daktronics, any defective part or component shall be returned to Daktronics for repair or replacement. This Warranty does not include on-site labor charges to remove or install these components. Daktronics may, at its option, provide on-site warranty service. Daktronics shall have a reasonable period of time to make such replacements or repairs and all labor associated therewith shall be performed during regular working hours. Regular working hours are Monday through Friday between 8:00 a.m. and 5:00 p.m. at the location where labor is performed, excluding any holidays observed by Daktronics.
- C. Daktronics shall pay ground transportation charges for the return of any defective component of the Equipment. All such items shall be shipped by End User DDP Daktronics designated facility per Incoterms® 2020. If returned Equipment is repaired or replaced under the terms of this Warranty, Daktronics will prepay ground transportation charges back to End User and shall ship such items DDP End User's designated facility per Incoterms® 2020; otherwise, End User shall pay transportation charges to return the Equipment back to the End User and such Equipment shall be shipped Ex Works Daktronics designated facility per Incoterms® 2020. All returns must be pre-approved by Daktronics before shipment. Daktronics shall not be obligated to pay freight for any unapproved return. End User shall pay any upgraded or expedited transportation charges
- D. Any replacement parts or Equipment will be new or serviceably used, comparable in function and performance to the original part or Equipment and warranted for the remainder of the Warranty Period. Purchasing additional parts or Equipment from the Seller does not extend the Warranty Period.
- E. Defects shall be defined as follows. With regard to the Equipment (excepting LEDs), a "Defect" shall refer to a material variance from the design specifications that prohibit the Equipment from operating for its intended use. With respect to LEDs, "Defects" are defined as LED pixels that cease to emit light. Unless otherwise expressly provided, this Warranty does not impose any duty or liability upon Daktronics for partial LED pixel degradation. Notwithstanding the foregoing, in no event does this Warranty include LED pixel degradation caused by UV light. This Warranty does not provide for the replacement or installation of communication methods including but not limited to, wire, fiber optic cable, conduit, trenching, or for the purpose of overcoming local site interference radio equipment substitutions.

EXCEPT AS OTHERWISE EXPRESSLY SET FORTH IN THIS WARRANTY, TO THE MAXIMUM EXTENT PERMITTED BY APPLICABLE LAW, DAKTRONICS DISCLAIMS ANY AND ALL OTHER PROMISES, REPRESENTATIONS AND WARRANTIES APPLICABLE TO THE EQUIPMENT AND REPLACES ALL OTHER WARRANTIES OR CONDITIONS, EXPRESS OR IMPLIED, INCLUDING, BUT NOT LIMITED TO, ANY IMPLIED WARRANTIES OR CONDITIONS OF MERCHANTABILITY, FITNESS FOR A PARTICULAR PURPOSE, OR ACCURACY OR QUALITY OF DATA. OTHER ORAL OR WRITTEN INFORMATION OR ADVICE GIVEN BY DAKTRONICS, ITS AGENTS OR EMPLOYEES, SHALL NOT CREATE A WARRANTY OR IN ANY WAY INCREASE THE SCOPE OF THIS LIMITED WARRANTY.

THIS LIMITED WARRANTY IS NOT TRANSFERABLE.

2. Exclusion from Warranty Coverage

This Warranty does not impose any duty or liability upon Daktronics for any:

- A. damage occurring at any time, during shipment of Equipment unless otherwise provided for in the Agreement. When returning Equipment to Daktronics for repair or replacement, End User assumes all risk of loss or damage, agrees to use any shipping containers that might be provided by Daktronics, and to ship the Equipment in the manner prescribed by Daktronics;
- B. damage caused by: (i) the improper handling, installation, adjustment, use, repair, or service of the Equipment, or (ii) any physical damage which includes, but is not limited to, missing, broken, or cracked components resulting from non-electrical causes;

DAKTRONICS WARRANTY & LIMITATION OF LIABILITY

altered, scratched, or fractured electronic traces; missing or gauged solder pads; cuts or clipped wires; crushed, cracked, punctured, or bent circuit boards; or tampering with any electronic connections, provided that such damage is not caused by personnel of Daktronics or its authorized repair agents;

- C. damage caused by the failure to provide a continuously suitable environment, including, but not limited to: (i) neglect or misuse; (ii) improper power including, without limitation, a failure or sudden surge of electrical power; (iii) improper air conditioning, humidity control, or other environmental conditions outside of the Equipment's technical specifications such as extreme temperatures, corrosives and metallic pollutants; or (iv) any other cause other than ordinary use;
- D. damage caused by fire, flood, earthquake, water, wind, lightning or other natural disaster, strike, inability to obtain materials or utilities, war, terrorism, civil disturbance, or any other cause beyond Daktronics' reasonable control;
- E. failure to adjust, repair or replace any item of Equipment if it would be impractical for Daktronics personnel to do so because of connection of the Equipment by mechanical or electrical means to another device not supplied by Daktronics, or the existence of general environmental conditions at the site that pose a danger to Daktronics personnel;
- F. statements made about the product by any salesperson, dealer, distributor or agent, unless such statements are in a written document signed by an officer of Daktronics. Such statements as are not included in a signed writing do not constitute warranties, shall not be relied upon by End User and are not part of the contract of sale;
- G. damage arising from the use of Daktronics products in any application other than the commercial and industrial applications for which they are intended, unless, upon request, such use is specifically approved in writing by Daktronics;
- H. replenishment of spare parts. In the event the Equipment was purchased with a spare parts package, the parties acknowledge and agree that the spare parts package is designed to exhaust over the life of the Equipment, and as such, the replenishment of the spare parts package is not included in the scope of this Warranty;
- I. security or functionality of the End User's network or systems, or anti-virus software updates;
- J. performance of preventive maintenance;
- K. third-party systems and other ancillary equipment, including without limitation front-end video control systems, audio systems, video processors and players, HVAC equipment, batteries and LCD screens;
- L. incorporation of accessories, attachments, software or other devices not furnished by Daktronics; or
- M. paint or refinishing the Equipment or furnishing material for this purpose.

3. Limitation of Liability

- A. Daktronics shall be under no obligation to furnish continued service under this Warranty if alterations are made to the Equipment without the prior written approval of Daktronics.
- B. It is specifically agreed that the price of the Equipment is based upon the following limitation of liability. In no event shall Daktronics (including its subsidiaries, affiliates, officers, directors, employees, or agents) be liable for any claims asserting or based on (a) loss of use of the facility or equipment; lost business, revenues, or profits; loss of goodwill; failure or increased cost of operations; loss, damage or corruption of data; loss resulting from system or service failure, malfunction, incompatibility, or breaches in system security; or (b) any special, consequential, incidental or exemplary damages arising out of or in any way connected with the Equipment or otherwise, including but not limited to damages for lost profits, cost of substitute or replacement equipment, down time, injury to property or any damages or sums paid to third parties, even if Daktronics has been advised of the possibility of such damages. The foregoing limitation of liability shall apply whether any claim is based upon principles of contract, tort or statutory duty, principles of indemnity or contribution, or otherwise
- C. In no event shall Daktronics be liable for loss, damage, or injury of any kind or nature arising out of or in connection with this Warranty in excess of the Purchase Price of the Equipment. The End User's remedy in any dispute under this Warranty shall be ultimately limited to the Purchase Price of the Equipment to the extent the Purchase Price has been paid.

4. Assignment of Rights

- A. The Warranty contained herein extends only to the End User (which may be the Purchaser) of the Equipment and no attempt to extend the Warranty to any subsequent user-transferee of the Equipment shall be valid or enforceable without the express written consent of Daktronics.

5. Governing Law; Election of Remedies

- A. The rights and obligations of the parties under this Warranty shall not be governed by the provisions of the United Nations Convention on Contracts for the International Sales of Goods of 1980. The parties consent to the application of the laws of the State of South Dakota to govern, interpret, and enforce each of the parties' rights, duties, and obligations arising from, or relating in any manner to, the subject matter of this Warranty, without regard to conflict of law principles.
- B. Any dispute, controversy or claim arising from or related to this Warranty, the parties shall first attempt to settle through negotiations. In the event that no resolution is reached, then such dispute, controversy, or claim shall be resolved by final and binding arbitration under the Rules of Arbitration of the International Chamber of Commerce. The language of the arbitration

DAKTRONICS WARRANTY & LIMITATION OF LIABILITY

shall be English. The place of the arbitration shall be Sioux Falls, SD. A single arbitrator selected by the parties shall preside over the proceeding. If a single arbitrator cannot be agreed upon by the parties, each party shall select an arbitrator, and those arbitrators shall confer and agree on the appointed arbitrator to adjudicate the arbitration. The arbitrator shall have the power to grant any provisional or final remedy or relief that it deems appropriate, including conservatory measures and an award of attorneys' fees. The arbitrator shall make its decisions in accordance with applicable law. By agreeing to arbitration, the Parties do not intend to deprive any court of its jurisdiction to issue a pre-arbitral injunction, pre-arbitral attachment, or other order in aid of arbitration proceedings and the enforcement of any award. Without prejudice to such provisional remedies as may be available under the jurisdiction of a court, the arbitrator shall have full authority to grant provisional remedies and to direct the Parties to request that any court modify or vacate any temporary or preliminary relief issued by such court, and to award damages for the failure of any Party to respect the arbitrator's orders to that effect.

6. Availability of Extended Service Agreement

- A. For End User's protection, in addition to that afforded by the warranties set forth herein, End User may purchase extended warranty services to cover the Equipment. The Extended Service Agreement, available from Daktronics, provides for electronic parts repair and/or on-site labor for an extended period from the date of expiration of this warranty. Alternatively, an Extended Service Agreement may be purchased in conjunction with this Warranty for extended additional services. For further information, contact Daktronics Customer Service at 1-800-DAKTRONics (1-800-325-8766).

Additional Terms applicable to sales outside of the United States

The following additional terms apply **only** where the installation site of the Equipment is located outside of the United States of America.

1. In the event that the installation site of the Equipment is in a country other than the U.S.A., then, notwithstanding Section 5 of the Warranty, where the selling entity is the entity listed in Column 1, then the governing law of this Warranty is the law of the jurisdiction listed in the corresponding row in Column 2 without regard to its conflict of law principles. Furthermore, if the selling entity is an entity listed in Column 1, then the place of arbitration is listed in the corresponding row in Column 3.

Column 1 (Selling Entity)	Column 2 (Governing Law)	Column 3 (Location of Arbitration)
Daktronics, Inc.	The state of Illinois	Chicago, IL, U.S.A.
Daktronics Canada, Inc.	The Province of Ontario, Canada	Toronto, Ontario, Canada
Daktronics UK Ltd.	England and Wales	Bristol, UK
Daktronics GmbH	The Federal Republic of Germany	Wiesbaden, Germany
Daktronics Hong Kong Limited	Hong Kong, Special Administrative Region of the P.R.C.	Hong Kong SAR
Daktronics Shanghai Co., Ltd.	The Peoples Republic of China	Shanghai, P.R.C.
Daktronics France, SARL	France	Paris, France
Daktronics Japan, Inc.	Japan	Tokyo, Japan
Daktronics International Limited	Macau, Special Administrative Region of the P.R.C.	Macau SAR
Daktronics Australia Pad Ltd	Australia	Sydney, Australia
Daktronics Singapore Pte. Ltd	Singapore	Singapore
Daktronics Brazil LTDA	Brazil	São Paulo, Brazil
Daktronics Spain S.L.U.	Spain	Madrid, Spain
Daktronics Belgium N. V	Belgium	Kruikeke, Belgium
Daktronics Ireland Co. Ltd.	Ireland	Dublin, Ireland

This page intentionally left blank.